



Department of
Building and Housing
Te Tari Kaupapa Whare



Guidance on Barrier Design

March 2012

Contents

1.0 Scope and Definitions	3
2.0 Guidance and the Building Code	6
3.0 Design Criteria	8
4.0 Materials	32
– Glass	32
– Timber	55
– Metals	59
– Wire in-fill	63
– Concrete	68
5.0 Checklist	69
6.0 References	71
7.0 Index of Diagrams	74
8.0 Index of Tables	75

B1
BUILDING CODE

Structure **B1**
BUILDING CODE

Durability **B2**
BUILDING CODE

Access routes **D1**
BUILDING CODE

External moisture **E2**
BUILDING CODE

Hazardous building materials **F2**
BUILDING CODE

Safety from falling **F4**
BUILDING CODE

ISBN: 978-0-478-38116-0 (online)

Published in March 2012 by
Department of Building and Housing
PO Box 10-729, Wellington, New Zealand.

This document is issued as guidance under section 175 of the Building Act 2004. While the Department has taken care in preparing the document it should not be relied upon as establishing compliance with all relevant clauses of the Building Act or Building Code in all cases that may arise. The Document may be updated from time to time and the latest version is available from the Department's website at www.dbh.govt.nz.



1.0 Scope and Definitions

1.1 Scope

This document brings together relevant information required for designers, manufacturers and installers of barriers. It explains ways to design and install New Zealand Building Code (NZBC) compliant barriers and is issued under section 175 of the Building Act 2004. It provides recommendations for the design and construction of permanent barriers that are required in and around buildings.

This guide is applicable to:

- barriers to decks, stairs and landings,
- walls, glazing (including screens and full-height glazing), fences and other elements of buildings where these elements prevent a fall of one metre or more.

It is advisable to apply the recommendations included in this guide to all building elements protecting a fall, although the NZBC does not require a barrier where the fall is less than one metre. Where barriers are installed in instances where the fall is less than one metre, certain NZBC requirements will still apply, e.g. Clause F2 Hazardous Building Materials.

This guide is not applicable to:

- barriers intended to stop or divert moving vehicles,
- barriers used in building work and construction,
- swimming pool fences safeguarding against a fall of less than one metre,
- barriers on walking tracks and bridges on walking tracks etc.

While this document is intended primarily for use by designers, sections on maintenance contain information beneficial to owners.

1.2 Definitions

For the purposes of this guide the following definitions apply. See also Figure 1.1.

Baluster Vertical members at close centres acting as the infill to a barrier.

Note: Balusters should not be confused with Structural Posts which are used in post and rail barrier systems.

Balustrade A balustrade is a row of balusters or other infill.

Note: A 'balustrade' is the commonly used term for a barrier.

Barrier Any building element intended to prevent a person from falling and to retain, stop or guide a person.

Boundary joist or joists A joist running along the outer ends of the floor joists.

Decking The material forming the walking surface of a floor or deck supported by joists.

Edge joist or joists A member or members at the perimeter (end) of a floor or deck running parallel to other joists.

Handrail A rail to provide support to, or assist with, the movement of a person.

Note: Where the handrail is used in an accessible route refer to paragraph 6.0 of Acceptable Solution D1/AS1.

Infill The building element (e.g. wires, rail, mesh, safety glass or other solid panel, louvres, balusters) spanning between supporting structure, posts or rails.

Rail A member used as a handrail, top rail, bottom rail or top edge capping in a barrier system.

bottom rail The lower rail supporting the barrier infill.

interlinking rail A rail (normally used with glass barriers) that is connected to each glass pane and/or to a structural post or other building element.

load-supporting rail A rail that is mechanically fixed to the structure, structural posts, or infill, that supports the applied design loads.

Note: Load-supporting rails are normally interlinking.

non-load-supporting rail A rail (normally used with glass barriers on the top edge of the glass) that does not carry the design loads alone, but relies on the glass to support the design loads.

Note: Non-load-supporting rails may be interlinking.

top rail The upper rail supporting the barrier infill which may also act as a handrail.

Safety glazing material Any material complying with Appendix 3A NZS 4223: Part 3:1999 Human Impact Safety Requirements.

Structural post A building element providing support for combinations of handrail, top and bottom rails and infill of a barrier.



Figure 1.1 Barrier elements

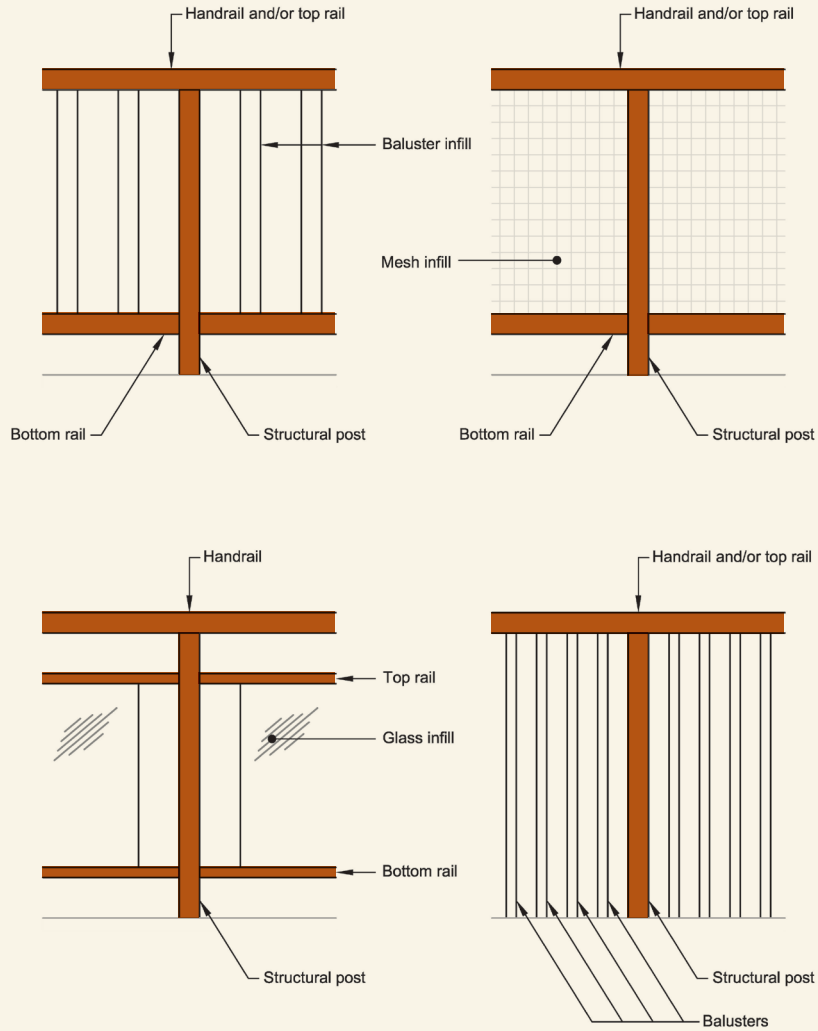
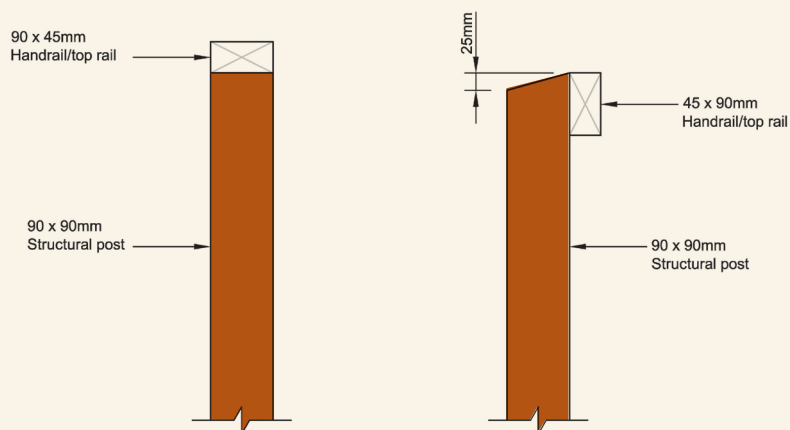

Figure 1.2 Handrail/top rail for timber barriers



2.0 Guidance and the Building Code

The aim of this document is to provide guidance on how the relevant Building Code performance criteria can be achieved for barriers.

Barriers are required to meet the performance criteria described in the Building Code. The relevant Building Code clauses for barriers are:

- B1 Structure
- B2 Durability
- D1 Access routes
- E2 External moisture
- F2 Hazardous building materials
- F4 Safety from falling

Some of these clauses may not apply for all installations. For example, Clause F2 Hazardous building materials, may not always apply because some barrier installations will not involve the use of hazardous building materials such as glass.

The objectives of each of these Building Code clauses are summarised in Table 2.1:

Table 2.1 Relevant Building Code clauses

Clause	Summarised objectives
B1 Structure	Protect people from injury or loss of amenity and protect other property from damage caused by structural failure.
B2 Durability	Ensure that throughout a building's life it will satisfy the other objectives of the Building Code
D1 Access routes	Safeguard people from injury during movement into, within and out of buildings.
E2 External moisture	Protect people from illness caused by external moisture entering the building.
F2 Hazardous building materials	Protect people from illness or injury and other property from damage caused by exposure to hazardous building materials.
F4 Safety from falling	Safeguard people from injury caused by falling.

The Building Act 2004 and the Building Code form the mandatory parts of the building controls regime. The Department's Acceptable Solutions and Verification Methods describe methods to comply with the performance criteria of the Building Code. Other ways may also be used to demonstrate compliance with the Building Code.

Barriers can be designed, manufactured and installed by using the Department's Verification Methods and Acceptable Solutions. However, it should be noted that Acceptable Solutions and Verification Methods:

- are not mandatory
- must be used within their scopes and limits
- are generic and do not include proprietary systems or products
- can be conservative because they are deemed to always comply with the Building Code
- and at times only describe one way to demonstrate compliance with the Building Code.

Not everyone wants a "one size fits all" building solution. A building owner may want something that looks different or performs better, is more cost effective, or overcomes a specific site problem. Whatever the reason, a non-generic approach to barrier design and construction may often be required.

This guidance predominately offers advice on how best to use the Acceptable Solutions and Verification Methods to achieve NZBC compliant barriers. However, in areas where the Acceptable Solutions and Verification Methods are limited, or even silent, this guidance offers additional information and advice on how to achieve NZBC compliant barriers. This will give designers and manufacturers the freedom to propose innovative solutions that provide the best outcome for each project but still meet the requirements of the Building Code. Refer to the Department's website www.dbh.govt.nz for further guidance on the use of Alternative Solutions.

This document helps set out what information and evidence the designer should provide to the Building Consent Authority (BCA) as part of a building consent application submitted by the owner.



3.0 Design Criteria

3.1 Introduction

Barriers must be designed to resist the loads (such as imposed and wind loads) they are likely to experience throughout their lives without collapsing or becoming unstable (see section 3.4) and without deflecting unacceptably, causing a loss of amenity (see section 3.5).

The barrier must also be sufficiently durable, without the need for reconstruction or major renovation, to function as required throughout its life (see section 3.8).

3.2 Design procedures

Barriers should be designed in accordance with the relevant clauses in the appropriate New Zealand materials Standards using the loads given in the Standard series AS/NZS 1170.

It is important that the design procedure takes account of the relevant aspects of durability, geometry, occupancy, strength and amenity to ensure the final design meets the requirements of the New Zealand Building Code. The design procedure for a typical barrier is set out in Figure 3.1.

When the barrier solution incorporates a proprietary balustrade system, a number of the steps in the design procedure should already have been undertaken by the manufacturer of the balustrade system. In these instances, the design effort should focus on ensuring that:

- the durability requirements of the specific application are met by the proprietary balustrade system, and
- the supporting structure is capable of accommodating the loads applied to the balustrade system without collapsing or excessive deflection.

The supplier of the proprietary balustrade system must provide evidence that the balustrade system meets the requirements of the Building Code. Section 5.0 provides guidance on what information is required to show compliance.

Figure 3.1 Barrier design procedure

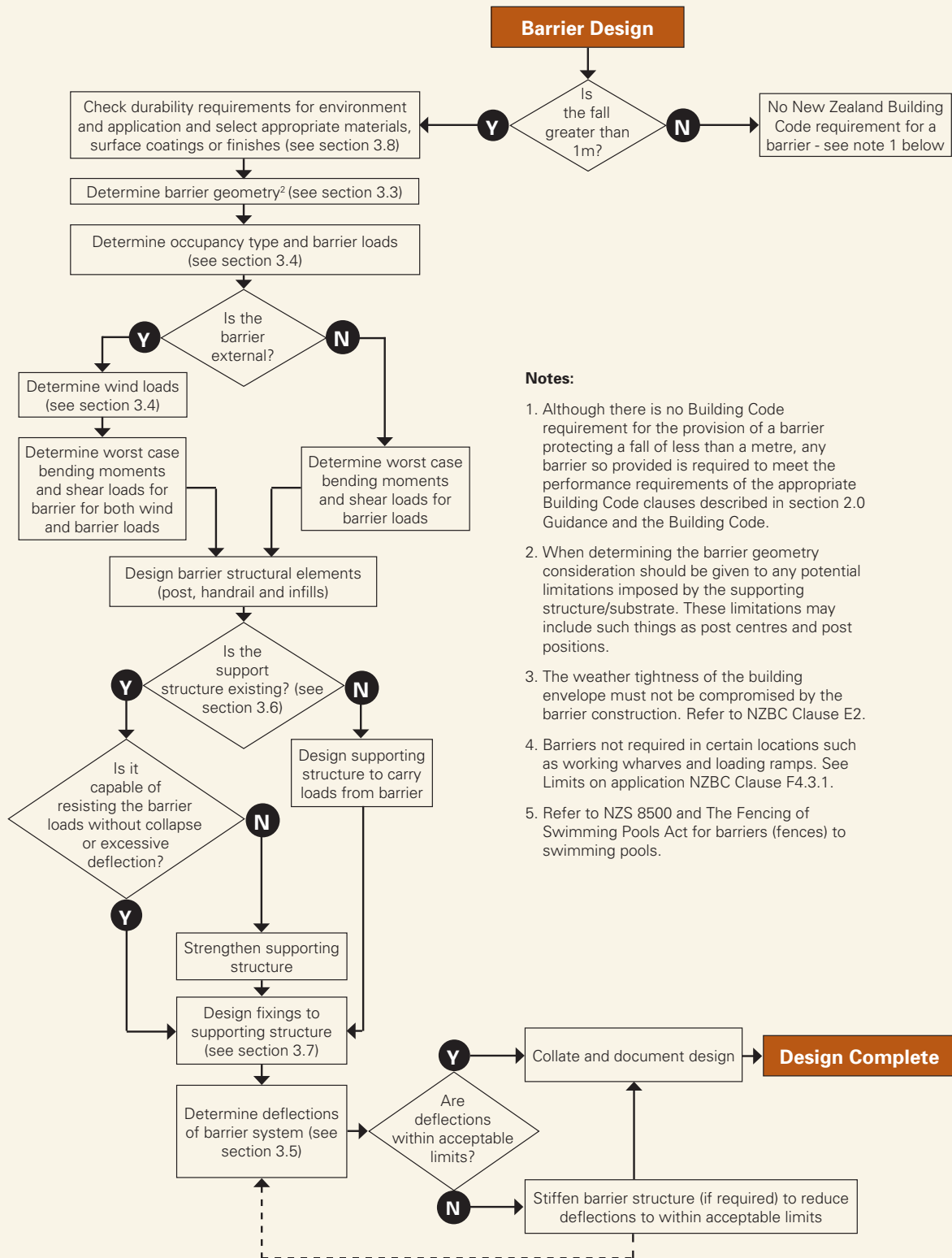

Notes:

1. Although there is no Building Code requirement for the provision of a barrier protecting a fall of less than a metre, any barrier so provided is required to meet the performance requirements of the appropriate Building Code clauses described in section 2.0 Guidance and the Building Code.
2. When determining the barrier geometry consideration should be given to any potential limitations imposed by the supporting structure/substrate. These limitations may include such things as post centres and post positions.
3. The weather tightness of the building envelope must not be compromised by the barrier construction. Refer to NZBC Clause E2.
4. Barriers not required in certain locations such as working wharves and loading ramps. See Limits on application NZBC Clause F4.3.1.
5. Refer to NZS 8500 and The Fencing of Swimming Pools Act for barriers (fences) to swimming pools.



3.3 Barrier geometry

Barriers must be continuous for the full extent of the potential fall. They must be sufficiently high to minimise the probability of a person falling over them and be constructed to prevent a person falling through them.

Barrier heights

The minimum barrier heights are given in Table 3.1. (Table 1 from Acceptable Solution F4/AS1.)

Table 3.1 Minimum barrier heights

Building type	Location	Minimum barrier height (mm) (Note 1)
Detached dwellings and within households units of multi-unit dwellings	Stairs and ramps and their landings ²	900
	Balconies and decks, and edges of internal floors or mezzanine floors	1000
All other buildings, and common areas of multi-unit dwellings	Stairs or ramps	900
	Barriers within 530mm of the front of fixed seating ³	800
	All other locations ⁴	1100

Note:

1. Heights are measured vertically from finished floor level (ignoring carpet or vinyl, or similar thickness coverings) on floors, landings and ramps. On stairs the height is measured vertically from the pitch line or stair nosings.
2. A landing is a platform with the sole function of providing access.
3. An 800mm high barrier in front of fixed seating would be appropriate in cinemas, theatres, and stadiums.
4. Not applicable to swimming pool fences or barriers. (Refer to NZS 8500)

Barrier geometry and infill construction

The purpose of the infill is to prevent a person from falling through the barrier and to restrict a child from climbing on or over the barrier.

In buildings likely to be frequented by children under six years of age the barriers must offer no easy or obvious means of climbing. They must provide no toe-holds between 150mm and 760mm above finished floor level. Examples of complying barriers are shown in Figure 3.3. For barriers with a ledge between 150mm and 760mm above floor level, the ledge depth must be 15mm or less unless it is sloped at 60 degrees below the horizontal towards the occupant – refer to Figure 3 F4/AS1 for an example. Furthermore, the openings anywhere in the barrier must be of such size that a 100mm diameter sphere cannot pass through them. The one exception to this is the triangular opening formed by the riser, tread and the bottom rail of the barrier on a stair where a 150mm diameter sphere is the maximum size that can pass through (see Figure 3.2 taken from Acceptable Solution F4/AS1).

In relation to Figure 3.2, while inclined rails are relatively difficult for children to climb, solid infill panels are harder to climb. Therefore, solid infill panels may provide a better solution for stair barriers in areas frequented by children.

Buildings classified as housing (Refer to Clause A1 of the First Schedule of the Building Regulations 1992) are always likely to be frequented by children under the age of six years and barriers in buildings described as housing must always have barriers designed with this in mind.

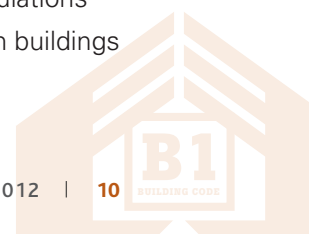
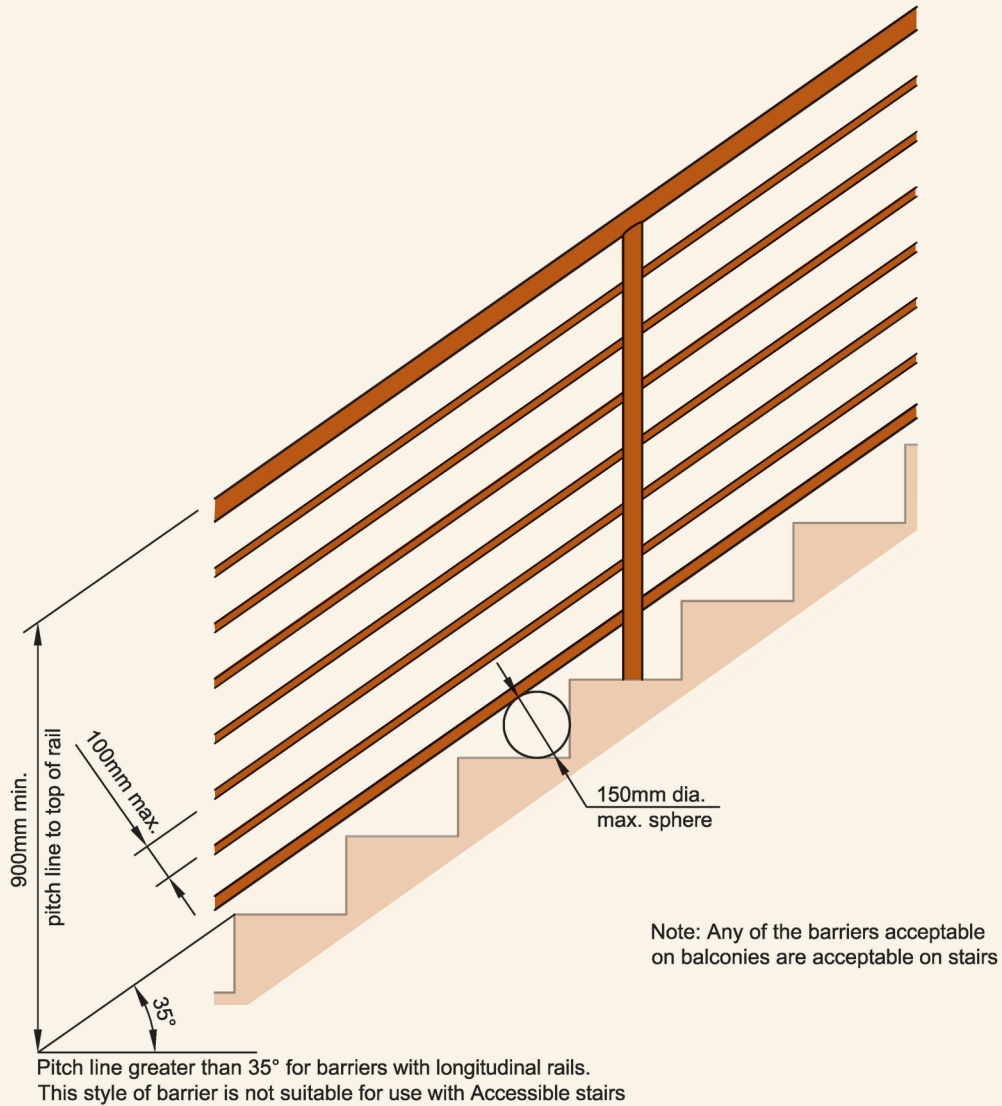

Figure 3.2 Stair barriers in areas likely to be frequented by children under six years of age



In areas used exclusively for emergency or maintenance purposes in buildings, and in other buildings not frequented by children, barriers may have openings with maximum dimensions of either 300mm horizontally between vertical members, or 460mm vertically between longitudinal rails.

Different parts of a building often have different barrier requirements. For example, shopping malls have public areas where children under six years old are expected to be present, and non-public areas unlikely to be frequented by children, for example, in areas used for food preparation or stock handling. The barrier infill in the public areas must be designed to prevent a child falling through the barrier and offer no easy or obvious methods of climbing.



Figure 3.3 (taken from Figures 1 and 2 of Acceptable Solution F4/AS1) gives examples of barrier constructions that are acceptable for areas likely to be frequented by children less than six years old. The openings and minimum distances to the top of rails shown in Figure 3.3 illustrate some constructions that limit opportunity for young children to gain toe-holds that would enable them to easily climb a barrier. In general, barriers with full-height vertical members are the hardest to climb for children while horizontal rails can easily be climbed by a two-year or older child.

Figure 3.3 Examples of barrier geometries

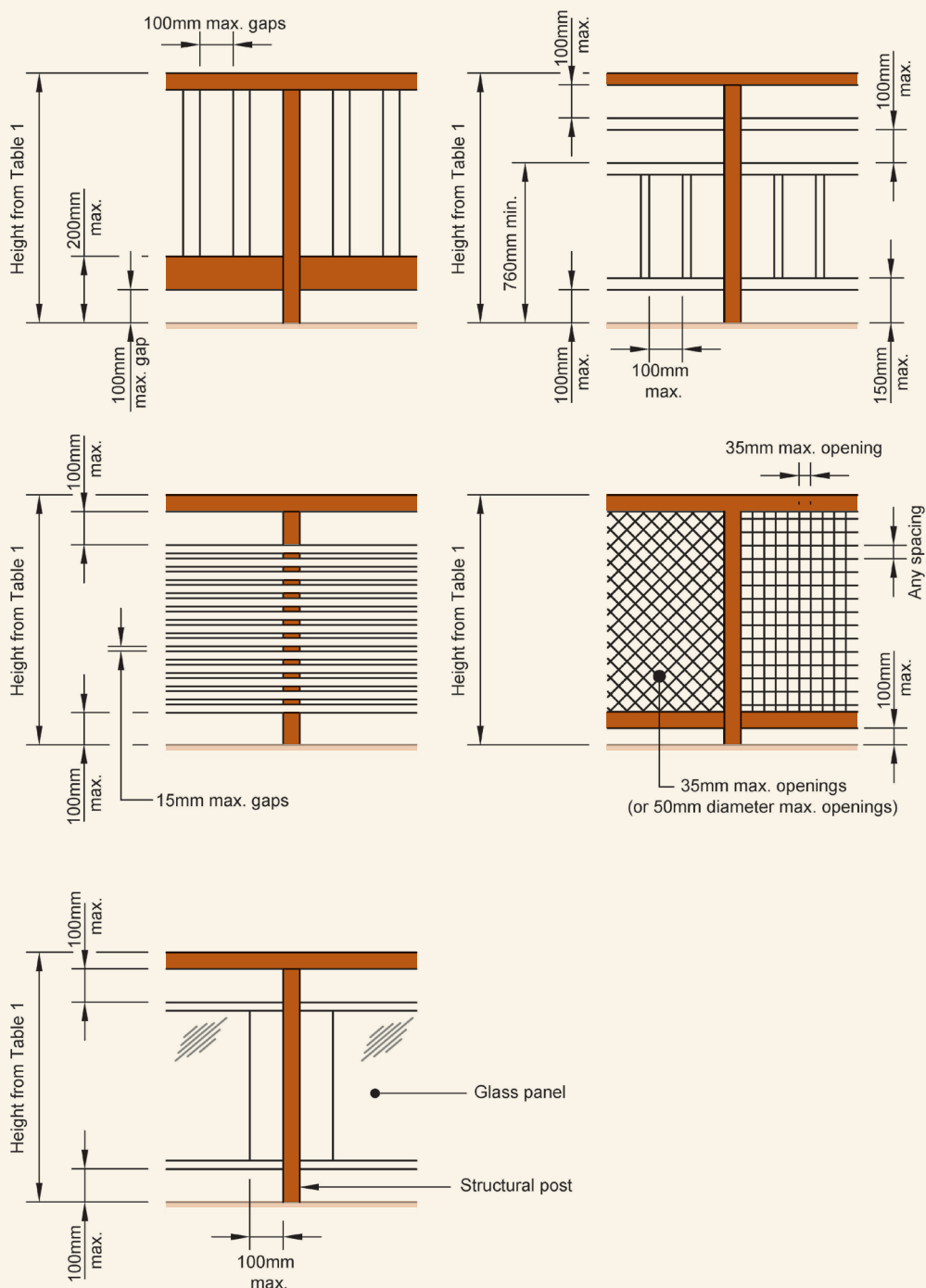

3.4 Loadings

Imposed loads (Live loads)

Barrier loads are set out in AS/NZS 1170.1 Clause 3.6 and Table 3.3. (Part of Table 3.3 of AS/NZS 1170.1 is reproduced below). The barrier loads must be multiplied by the appropriate combination factors for both the ultimate and serviceability states as given in Section 4 of AS/NZS 1170.0 in order to be used in the design of the barrier system. It should also be noted that these loads are to be modified by the requirements of B1/VM1, which modifies some of the loadings of the Standard series AS/NZS 1170.

Barrier imposed loads are described in Table 3.3. The magnitude of the barrier loads that need to be applied in the design depends specifically on the occupancy of that part of the building or structure. Therefore it is important to select the correct occupancy when designing barrier elements. It is the responsibility of the owner/designer to determine the occupancy classification. If there is any doubt regarding which occupancy is appropriate for the particular circumstance it is recommended that the designer seek the advice of the Building Consent Authority.

For domestic and residential buildings Table 3.3 makes a distinction in terms of the magnitude of loads between barriers:

- within a single dwelling
- on external balconies and edges of roofs
- in multi-unit, group or communal residential dwellings.

Note:

1. The term 'external balconies' applies to decks, balconies, verandahs and the like.
2. There are different load requirements for barriers within, or exclusively serving, an individual dwelling unit (Type/occupancy A) and barriers in the common or shared areas of apartment buildings, external balconies and edges of roofs (Type/occupancy C3) shown in Table 3.3.

With regard to over-crowding and occupancy type C5, it is only necessary to use C5 (3kN/m horizontal top edge) in the areas susceptible to overcrowding. Furthermore, in areas susceptible to overcrowding where it can be shown that the direction of people movement is parallel to the barrier, e.g. stairs, it is possible to reduce the horizontal top edge loading from 3kN/m to 2kN/m. In areas where the movement of people may be perpendicular to the barrier, e.g. spectator galleries, the horizontal top edge loading can be reduced below 3kN/m if the depth perpendicular to the barrier from either the rear wall or any other fixed constraint is less than 3.4 metres. See Table 3.2 and Figure 3.4 for more details.

Table 3.2 Barrier Loadings for areas susceptible to overcrowding

Depth measured perpendicular to barrier	3.4m	2.3m	1.7m
Minimum horizontal top edge load	3.0kN/m length	2.0kN/m length	1.5kN/m length

Note:

1. Interpolation may be made between these figures.
2. If the area forms part of an escape route, the barrier's horizontal imposed load must be no less than 2.0 kN/m length.



Table 3.3 Barrier imposed loads

Type of occupancy for part of the building or structure	Specific uses	Top Edge and Rail			Infill		
		Horizontal	Vertical	Inwards, outwards or downwards	Horizontal	Any direction (see Note 2)	
		kN/m	kN/m	kN	kPa	kN	
A Domestic and residential activities	All areas within or serving exclusively one dwelling including stairs, landings etc. but excluding external balconies and edges of roofs (see C3)	0.35	0.35	0.6	0.5	0.25	
	Other residential (see also C)	0.75	0.75	0.6	1.0	0.5	
B,E Offices and work areas not included elsewhere including storage areas	Light access stairs and gangways not more than 600mm wide	0.22	0.22	0.6	N/A	N/A	
	Fixed platforms, walkways, stairways and ladders for access (see Note 1)	0.35	0.35	0.6	N/A	N/A	
	Areas not susceptible to overcrowding in office and institutional buildings also industrial and storage buildings	0.75	0.75	0.6	1.0	0.5	
C Areas where people may congregate							
C1/C2	Areas with tables or fixed seating	Areas with fixed seating adjacent to a balustrade, restaurants, bars etc.	1.5	0.75	0.6	1.5	1.5
C3	Areas without obstacles for moving people and not susceptible to over crowding	Stairs, landings, external balconies, edges of roofs etc.	0.75	0.75	0.6	1.0	0.5
C5	Areas susceptible to over-crowding	Theatres, cinemas, grandstands, discotheques, bars, auditoria, shopping malls (see also D), assembly areas, studios etc.	3.0	0.75	0.6	1.5	1.5
D	Retail areas	All retail areas including public areas of banks/building societies, (see C5 for areas where overcrowding may occur)	1.5	0.75	0.6	1.5	1.5

Note:

1. This usage (under B, E) is for access to and safe working at places normally used by operating, inspection, maintenance and servicing personnel.
2. Applied over a circular or square area of 2000mm², or over two adjacent vertical balusters, as appropriate.



Figure 3.4 Barrier Loads for areas susceptible to overcrowding

This diagram illustrates the positions and design loads of barriers used with seating decks, stairways and gangways.

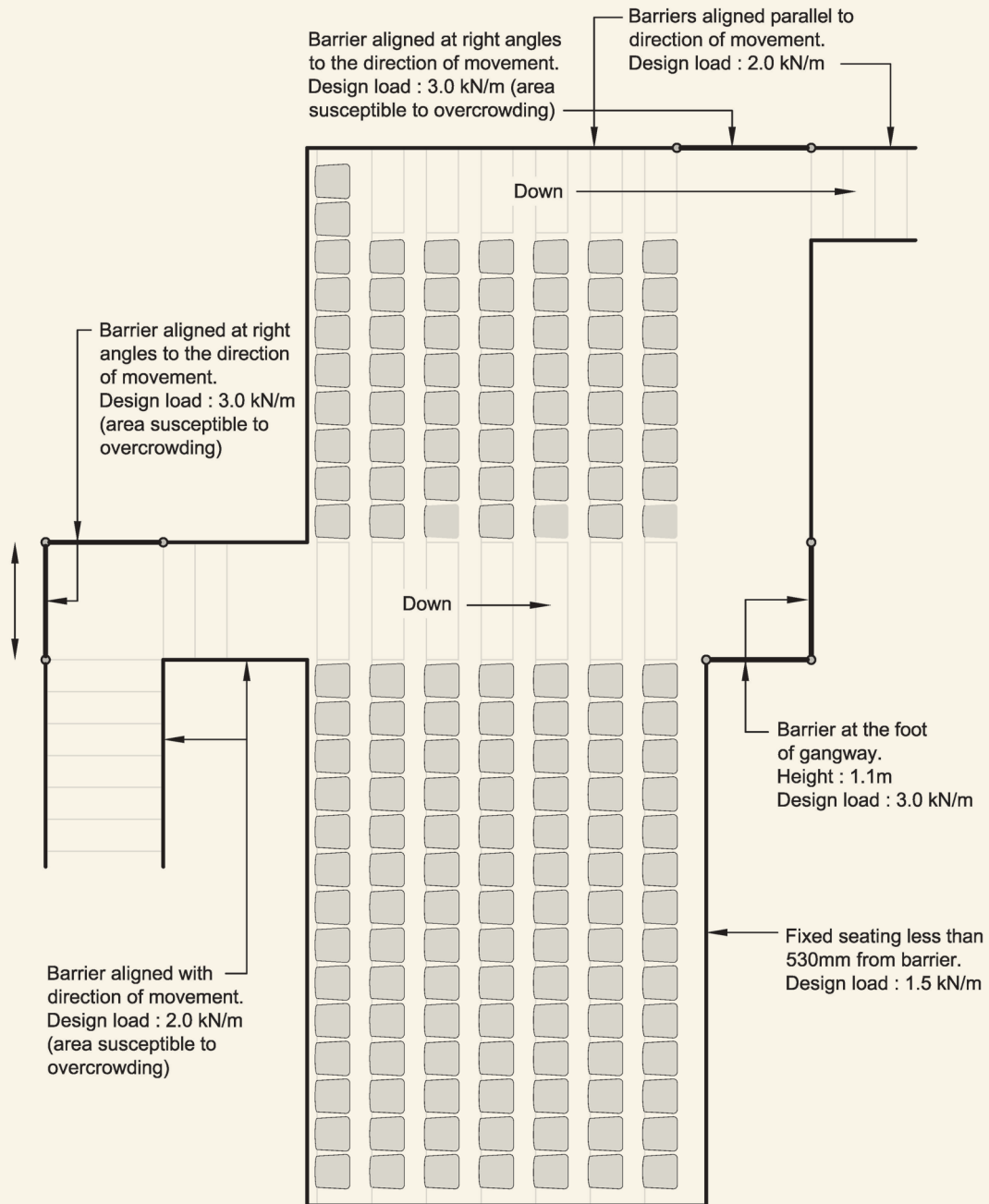

Further information can be found in BS EN 13200:2005 Spectator Facilities - Part 3: Separating elements – Requirements and Guide to Safety at Sports Grounds, published by Department of Culture, Media and Sport (UK).



Barrier loads are modified by B1/VM1 paragraph 2.2.7 which defines the extent and point or line of application for the barrier loads. Line loads (top edge loads), concentrated loads (top edge and infill loads), and infill loads are to be applied as four separate load cases. These load cases are not additive. The following sections on line, infill and concentrated loads include diagrams and explanations of these modifications.

Line loads (top edge loads)

Line loads need not be applied more than 1200mm above the finished floor or stair pitch line.

Domestic and residential buildings

B1/VM1 paragraph 2.2.7 (a) (i) modifies AS/NZS 1170.1 Clause 3.6 which relates to all domestic and residential barriers including external balconies.

Barriers with a rail

The diagrams following show how line loads (Q) are to be applied to domestic and residential barriers with rails. Each must be considered as a separate load case.

- Figure 3.5 A and B – When a barrier has a rail or rails, apply the horizontal line load (Q) directly to the top rail.
- Figure 3.5 C – When the barrier or rail is more than 1200mm above the floor or stair pitch line, apply the horizontal line load (Q) at a height no more than 1200mm above the floor or stair pitch line.
- Figure 3.5 D – If the top of the barrier is not a rail, but a rail is within 200 mm of the top of the barrier, apply 50% of the horizontal line load (Q) to the top of the barrier.
- Figure 3.5 E – If there is no rail within 200mm of the top of the barrier, apply the full horizontal line load (Q) to the top of the barrier, but not more than 1200mm above the floor or stair pitch line.
- Figures 3.5 F – Apply the vertical line load (Q) directly to the top of the barrier. Designers may also choose to check any separate top rail that is not the top of the barrier for the vertical line load.



Figure 3.5 Domestic and residential barriers with rails

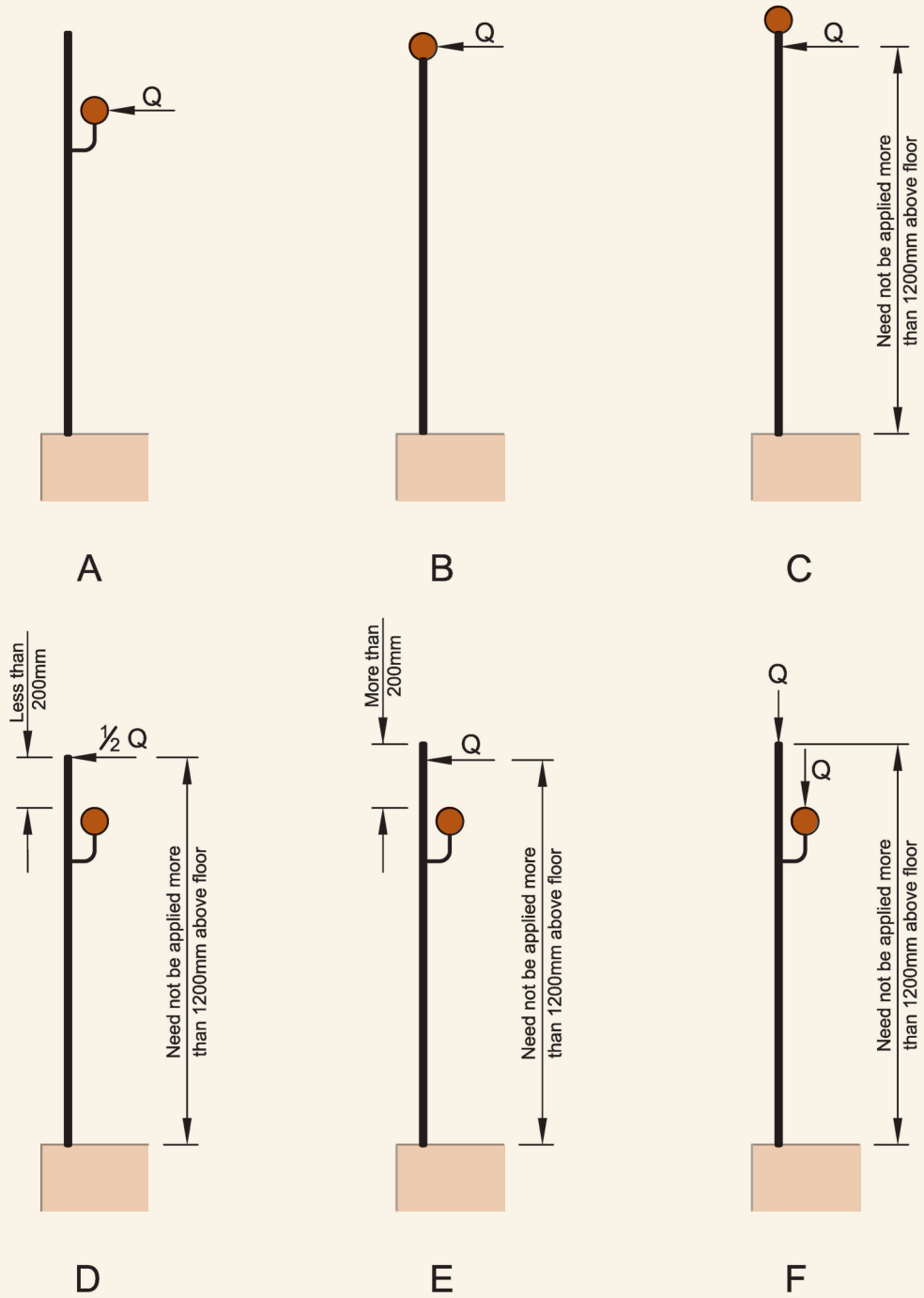

Barriers without a rail

The diagrams following show how line loads (Q) are to be applied to domestic and residential barriers without a rail.

- Figure 3.6 A – Apply the full horizontal line load at 900mm above the floor or stair pitch line.
- Figure 3.6 B – Separately, apply 50% of the horizontal line load to the top of the barrier. If the height of the barrier is greater than 1200mm, apply the horizontal line load at a height of 1200mm above the floor or stair pitch line.
- Figure 3.6 C – Apply the vertical line load to the top of the barrier.

Figure 3.6 Domestic and residential barriers without a rail

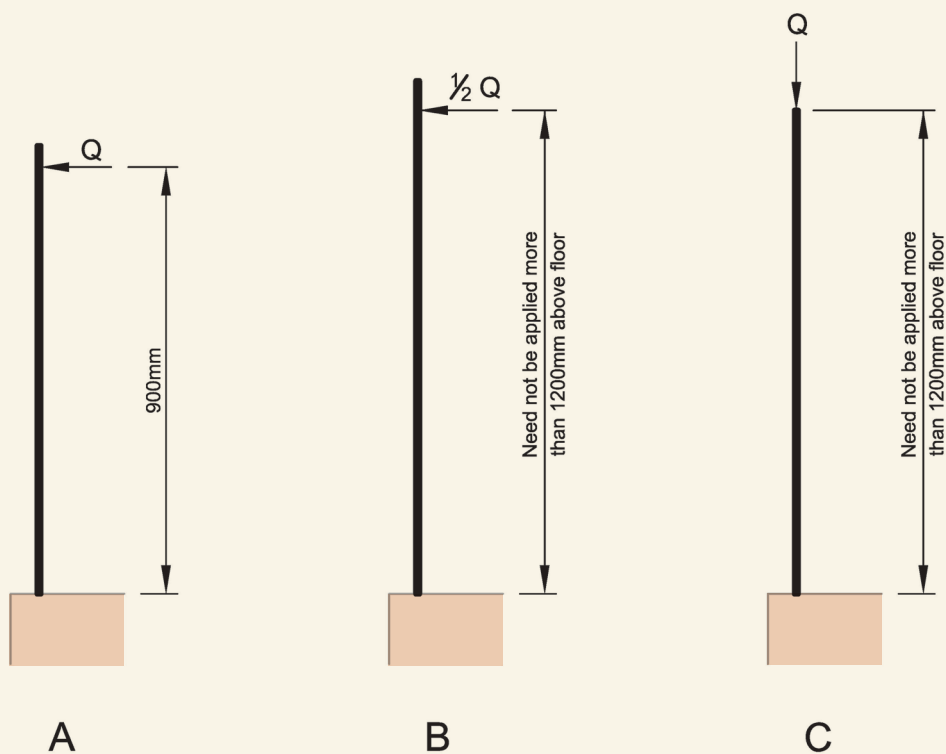

Buildings other than domestic and residential

Barriers with or without a rail

The following diagrams show how line loads (Q) are to be applied to barriers in and around buildings that are not domestic or residential.

- Figure 3.7 A – Apply the horizontal line load (Q) to the top edge of the barrier, but not at a height greater than 1200mm above the floor or stair pitch line.
- Figures 3.7 B and C – Where there is a rail, apply the horizontal line load (Q) to the top rail of the barrier.
- Figure 3.7 D – If the top of the barrier is not a rail, but a rail is within 200mm of the top of the barrier, apply 50% of the horizontal line load (Q) to the top of the barrier.
- Figure 3.7 E – If there is a rail but it is not within 200mm of the top of the barrier, apply the full horizontal line load (Q) to the top of the barrier, but not more than 1200mm above the floor or stair pitch line.
- Figure 3.7 F – In all cases, apply the vertical load directly to the top of the barrier and separately to the top rail.

Figure 3.7 Non-domestic and non-residential barriers

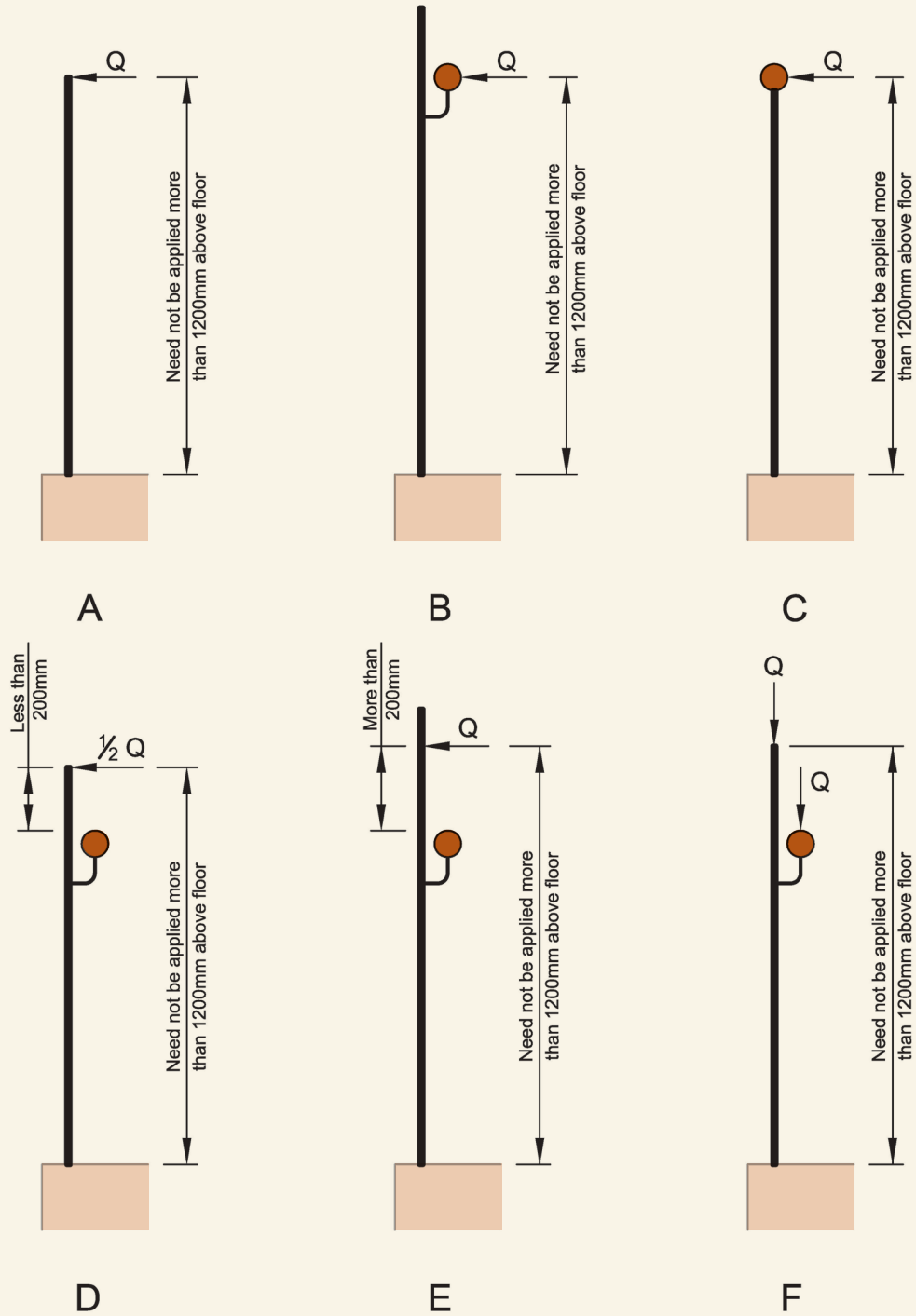

Infill (distributed) loads

All buildings

Figure 3.8 shows how infill loads (P) are applied to barriers.

- Figure 3.8 A and B – Apply the infill load (P) over the whole area of the barrier from the top of the barrier down to the floor.
- Figure 3.8 C – Distribute the applied load to the appropriate load-bearing element.
- Distributed loads may be reduced by 50% between 1200mm and 2000mm above floor level and do not need to be applied above 2000mm from the floor.

Note that barriers have to resist other loads, such as wind, which are considered as separate load cases.

Figure 3.8 Infill loads on barriers

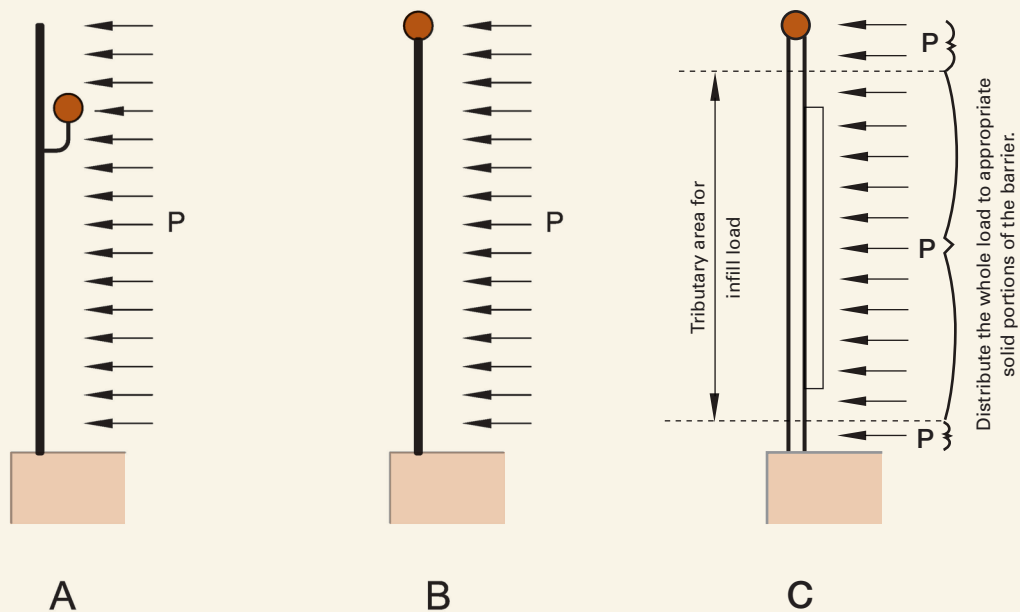

Concentrated loads

There are two types of concentrated loads in AS/ NZS 1170.1. These are concentrated top edge loads and concentrated infill loads. The top edge concentrated loads are applied inwards, outwards and downwards over a square or circular area of 2000mm².

It should be noted that when a barrier has closely-spaced posts the concentrated top edge loads can often exceed the top edge line load requirements.

In the case of cantilevered barriers without posts or a rail, i.e. where the infill extends to the top of the barrier and is therefore both the top edge and the infill, both concentrated loads are also applied to the top of the barrier. This can be a critical load case when the concentrated infill loads, for certain occupancy types, exceed the concentrated top edge loads.

All buildings

Apply the concentrated load (F) at locations to produce the most severe effect on the structural element being considered.

- Figure 3.9 A – When the load position is not more than 1200mm above the floor or stair pitch line, apply the full concentrated load (F).
- Figure 3.9 B – When the load position is more than 1200 mm above the floor, apply 50% of the concentrated load (F) to the barrier top edge or rail.
- Figure 3.9 C – The concentrated load must be applied in the direction and location which produces the most severe effects on the element or connection being considered.
- Figure 3.9 D – If the barrier consists of vertical members less than 100 mm in width and with a gap of less than 100mm between the vertical members, the concentrated load can be split equally between two adjacent vertical members.



Figure 3.9 Concentrated loads on barriers

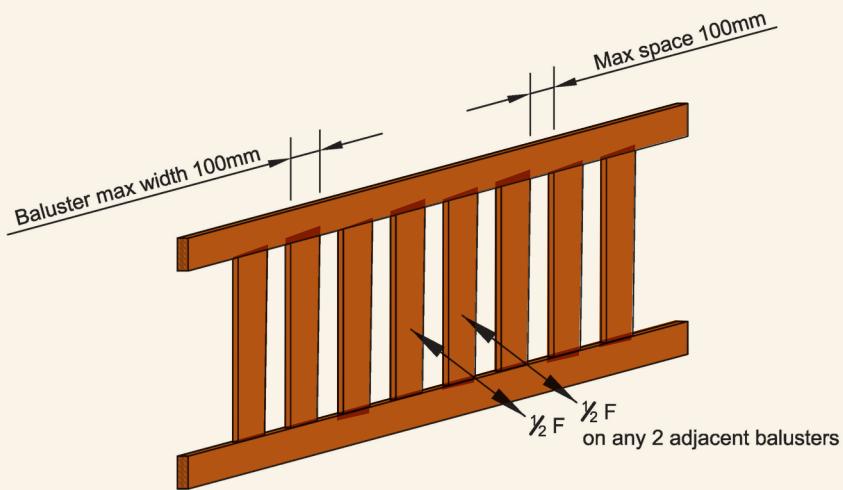
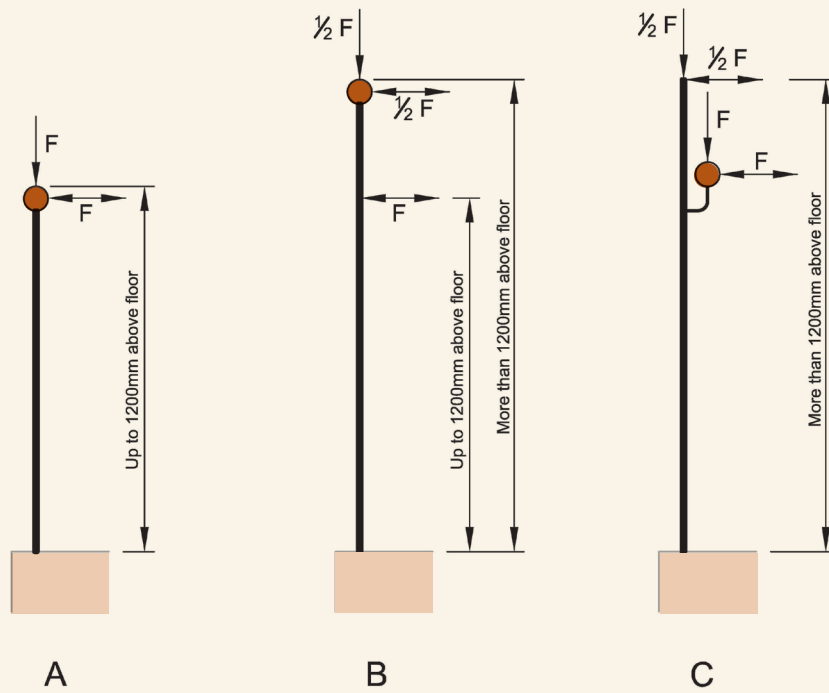

D Concentrated loads on a barrier with parallel narrow vertical members



Wind loads

External barriers should be designed to resist the wind loads derived from AS/NZS 1170.2. Wind loads can be the critical loading condition and control the design of the barrier structure when the barrier infill is solid (such as in the case of glass barriers). Particular attention should be paid to high rise buildings and exposed residential buildings where wind loads over twice that of the barrier infill loads are possible.

Free-standing screens over 1500mm high, walls, and full height glazing acting as a barrier

Clause B1 Structure of the Building Code requires people to be safeguarded from injury caused by structural failure and requires account to be taken of all loads likely to affect the stability of a building element, including imposed, wind and impact loads. Furthermore, NZBC Clause F4 Safety from Falling requires people to be safeguarded from injury caused by falling and therefore requires a barrier to be provided where people could fall one metre or more to reduce the likelihood of accidental fall and injury.

This means that building elements such as tall screens, full height glazing, internal and external walls and windows that protect a difference in level of 1m or more are barriers and therefore must be able to withstand the likely imposed, wind and impact loads without failure.

The most appropriate way to comply with these requirements is to design all building elements that act as a barrier in accordance with the B1/VM1 Verification Method (specifically AS/NZS 1170 Parts 1 and 2). However, for walls and full height glazing, the Verification Method B1/VM1 may not always be entirely appropriate and could result in an overly conservative design. In this instance it may be more appropriate to adopt an alternative solution approach as follows.

Addressing the three types of barrier loads in the Standard series AS/NZS 1170 (top edge loads, distributed infill loads and concentrated infill loads) in turn:

- **Top edge line loads**

When the building element does not have a top edge and is greater than 1500mm high, such as in the case of many walls and full height glazed screens, the top edge loads may be omitted. However where a handrail, rail or transom is present, which could attract a line load in the event of people pressing against the building element, the top edge loads are applied to this element. For free-standing screens which are less than 1500mm high the designer should apply the rules as set out in B1/VM1 with regards to the application of line loads.

- **Infill loads**

Infill distributed loads should always be applied as a minimum and may be exceeded by the wind loads. Distributed loads may be reduced by 50% between 1200mm and 2000mm above floor level and do not need to be applied above 2000mm from the floor.

- **Concentrated loads – top edge and infill**

Generally, top edge concentrated loads should always be applied to any handrail, rail or transom, and concentrated infill loads applied to the infill in a location having the worst effect, but no higher than 1200mm above floor level. If no handrail, rail or transom exists, only the concentrated infill loads are applied to the infill in a location having the worst effect but no higher than 1200mm above floor level.

3.5 Deflection

General

Beyond the NZBC requirements for barriers to be of adequate strength and stiffness to sustain the applied loads without causing loss of amenity through undue deflection, there are no further mandatory requirements for deflections. Therefore, the key requirement for deflections of barriers is that deflections are limited to prevent people becoming apprehensive or distressed due to excessive movement of the barrier when in normal use.

Note that the commentary to AS/NZS 1170.1 includes guidance on deflections of barriers.

Deflections due to wind and infill loads

Wind load deflections occur frequently for external barriers and are often critical for the design of impermeable material barriers such as those of glass or with glass infills. In windy locations and high rise buildings, the wind load deflection may exceed deflection caused by top edge and concentrated loads. For low-rise buildings, sheltered and internal barriers, deflections caused by barrier infill loads are more critical than deflections due to wind pressures.

Deflections due to top edge loads

Top edge and concentrated load deflections occur when people push or are pushed hard (e.g. in a crowd surge) against the top edge, handrail or corner of a barrier. These loads should not occur on a regular basis, and are perhaps less critical in terms of design for amenity. However, in normal use with people leaning or resting against a barrier the deflection of the barrier should not make the occupant feel uncomfortable.

Recommended deflection limits

When considering deflection limits it is the total horizontal displacement of the barrier at any point from its original unloaded position which is most critical. The total horizontal displacement is recommended not to exceed 30mm under barrier and wind loads described in B1/VM1.

For serviceability, the horizontal deflection of post and rail balustrade systems (measured at the handrail/ top rail) may be considered acceptable if it does not exceed $H/60 + L/240$ or 30mm, whichever is smaller, where H is the height of the handrail/top rail above the top of the supporting structure (deck or slab) and L is the distance between the centres of the supporting posts to the handrail (see Figure 3.10 below).

It is recommended that the deflections of tall barriers are measured at 1200mm above finished floor level to determine the maximum deflection.



When calculating deflections of barrier structures, it is important to make allowance for any twisting and rotating of the supporting structure. This is most important when the barrier is fixed to the perimeter of a cantilevered balcony or timber deck as these structures often deflect and distort to a significant extent. A number of proprietary barrier designs assume zero rotation at the support in their associated documentation. In these cases, the designer must:

- a) make an assessment of the validity of this assumption in relation to the particular supporting structure under consideration, and
- b) determine whether the actual deflections will be within acceptable limits.

Figure 3.10 Horizontal deflection of post and rail balustrade

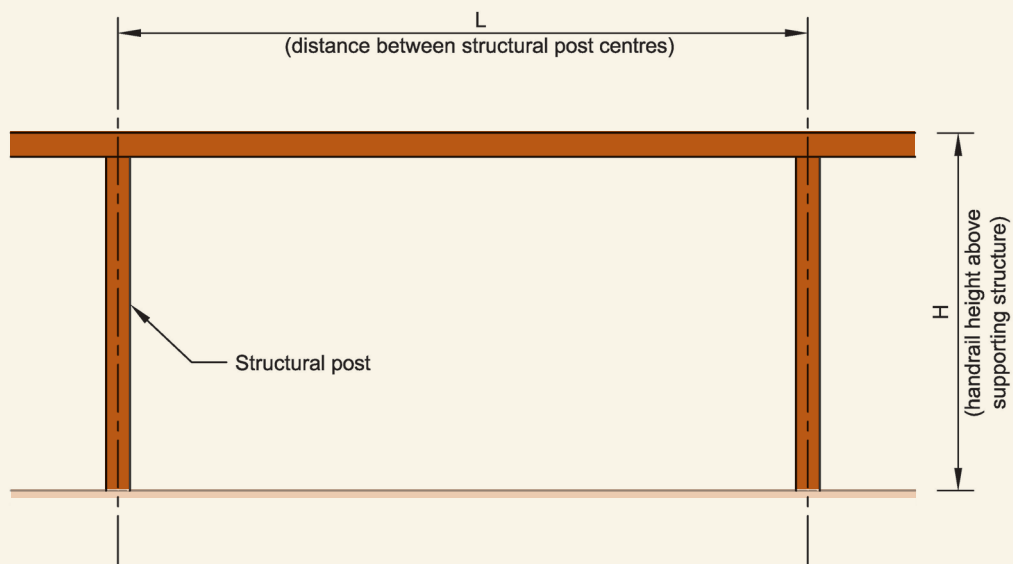

3.6 Supporting structure

Barriers need to be designed and constructed so that they are capable of providing the strength and stiffness necessary for the proposed location and occupancy. Not only does the barrier need to have sufficient strength and stiffness, but the supporting structure to which the barrier is connected must have adequate strength and stability to sustain all applied loads safely without excessive stress, deflection or distortion.

3.7 Fixings and connections

The fixings securing the barrier system to the supporting structure are of key importance and must have at least equivalent strength to that of the rest of the barrier system. Furthermore, it is recommended all member joints in the barrier be designed to provide the full strength of the members being connected. This is to ensure that under extreme loading the barrier will indicate failure by deflection and distortion rather than by rupture and sudden collapse, as would be brought on by failure of a fixing or connection.

When designing fixings, consideration must be given to the substrate into which the fixing is being placed. Substrate (material and strength) and fixing (type, edge distance and spacing) all affect the capacity of the connection. When it is not possible to calculate the capacity of the fixing into a substrate with reasonable accuracy, then load testing should be carried out to validate the design and an appropriate factor of safety applied to the loading. This can often be the case when the substrate is existing and of unknown strength.

The integrity of the buildings cladding system must be maintained. Fixing penetrations through claddings must be designed to prevent the penetration of water that could cause undue dampness or damage to building elements.



3.8 Durability

The durability requirements of building elements are covered by New Zealand Building Code Clause B2. For barriers, one way to comply with NZBC Clause B2 is to use Acceptable Solution B2/AS1 which sets out how to determine the durability requirements for building elements. Figure 3.11 sets out the specific durability requirements for barriers.

Clearly, the supporting structure has a 50-year durability requirement as it is part of the building's structure. The posts and handrails normally also have a 50-year durability requirement. This is based on the assumption that the building element (post/rail) is either difficult to access and replace, or that failure would go undetected in both normal use and maintenance. However, if it can be shown that the post, handrail and fixings can be accessed and replaced without difficulty and that failure would not go undetected, then it would be acceptable to reduce the durability requirements for these elements to 15 years. Likewise, if the barrier infill was difficult to access and replace or failure of the infill would go unnoticed, e.g. the support of the infill is hidden, then the durability requirements of the barrier infill would need to be increased.

It should be noted that failure in this instance means no longer complying with other clauses of the New Zealand Building Code.

Figure 3.11 Assessment of durability for barriers

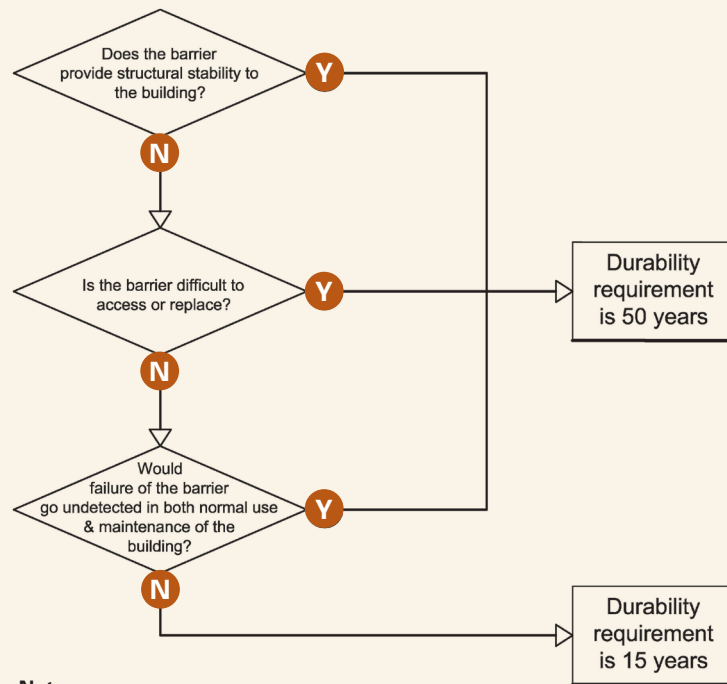

Note:

1. Building elements shall not be required to satisfy a durability performance which exceeds the specified intended life of the building.

Another option within the Acceptable Solution is to use Table 1 of B2/AS1. This table sets out specifically the durability requirements for most building elements. Figure 3.12 below details these requirements for barriers.

Figure 3.12 Barrier and supporting structure durability requirements

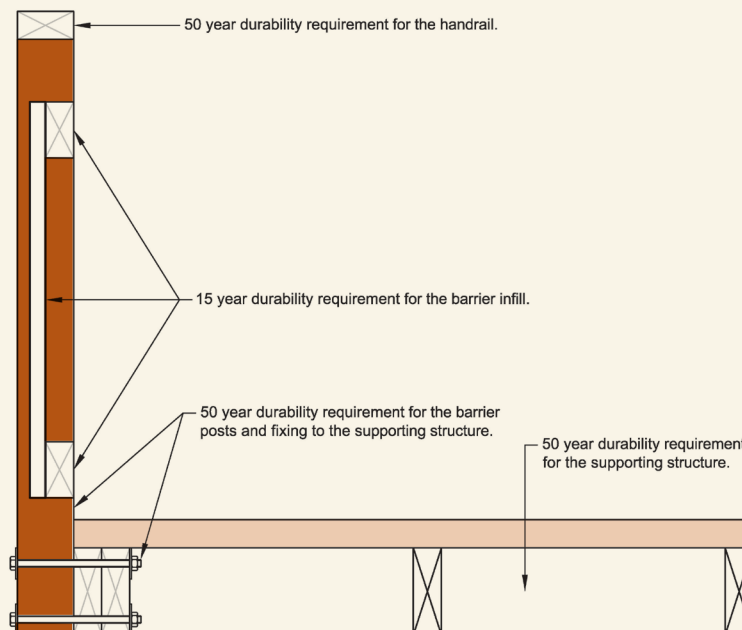

For information on material compatibility in relation to durability refer to Acceptable Solution E2/AS1 Tables 20 to 22.



3.9 Safety details

The barrier including the infill should have no sharp edges or projections that may cause injury when restraining people. Consideration also needs to be given to the possibility of tampering and vandalism when designing for safety.

3.10 Testing procedures/protocols

Test Loads

Barriers are required to resist a range of minimum “design loads”. These loads are specified in Table 3.3 AS/NZS 1170.1 for the various occupancy types. (Reproduced in part as Table 3.3 in this document).

The loads are either applied as line loads, point loads or uniform (pressure) loads. These are unfactored imposed (live) loads. A designer conducting an analytical design of a barrier system is required to factor the loads according to AS/NZS 1170.0 to allow for uncertainty in the actual value of the loads in practice, as would be done with the design of other structural elements.

With calculations for barriers, the factor to be used by the designer for strength is 1.5 and for service (deflections) 1.0.

When tests are undertaken to establish the strength and stiffness of barrier systems, there is no particular standard that specifies how this is to be done. However, the tests that will be undertaken are effectively prototype tests and guidance is provided in Appendix B of AS/NZS 1170.0 on the load multiplier that should be used when conducting such tests on barrier systems. This multiplier is determined on the basis of the variation in the structural characteristics of the system. The variation may not be known, and if a single test is to be conducted on the system for a particular load condition there is no opportunity to ascertain the variation. However, the materials being used in the construction of the barrier are likely to be reasonably well known (timber has the greatest variability of the majority of materials that will form a part of a barrier) and an estimate of the likely variability can be made. Once this is made, the test target load level can be established by multiplying the factored design load by the load multiplier. By conducting several replicate tests, a greater confidence can be established in the likely performance of the system in service and the test target loads can be reduced (in accordance with Table B1 of AS/NZS 1170.0).

It is important to correctly model the critical service conditions in the tests. For example, the base fixing of the barrier to the substrate must be correctly modelled: fixing a baseplate which is expected to be installed on a timber substrate to a heavy steel substrate in the laboratory will not adequately model the expected service deflections. Similarly, components within the system must be faithfully modelled.

The sequence of load application on a test specimen is important to ensure the greatest benefit can be obtained from the tests. The best sequence can be estimated by pre-test calculation of likely failure loads of the components of the system to determine the weakest element and under which load failure is most likely to occur.

Load durations

The specimen shall be loaded at a constant rate with deflections preferably recorded continuously. The duration of the test should not be less than five minutes.

Test specimen conditioning

The performance of some materials in the field is likely to be governed by the weather, particularly rain. For example, timber elements are likely to undergo moisture content changes with the seasons, particularly if they are not paint protected. A system under test should have a moisture condition as near as possible to that which it would experience in service. If the system is unprotected and exposed to rain, then the moisture condition of the test specimens should be high enough to accurately simulate the field behaviour. Normal fluctuations in air temperature are not likely to affect the performance of any barrier system.

Application of the test loads to the specimen

The test loading must accurately simulate the loads specified in the loadings Standard. The line load, for example, must be applied without the possibility of the application rig strengthening the barrier system – and the uniform pressure load should generally be just that. This is especially important for elements of the infill system that “span” in two directions, such as panel products that are supported along all four edges. It will be appropriate to use a series of line loads to simulate the pressure loads on some occasions, but the appropriateness must be agreed with the testing authority prior to conducting the testing.

Testing safety

When a test load is being applied to a specimen a significant amount of potential energy can accumulate as the system displaces under load. Testing laboratories should always estimate the likely physical behaviour of the specimen should it fail under load, and ensure those witnessing the test are kept at a safe distance from the specimen.



4.0 Barrier materials

4.1 Glass

4.1.1 Glass type

Glass used in barriers shall be toughened or laminated safety glass complying with Appendix 3.A, Schedule of safety glazing materials in NZS 4223: Part 3:

Note: *Laminated safety glass can be annealed, heat strengthened or toughened laminated glass.*

4.1.2 Glass marking

All safety glass must be permanently marked in accordance with the minimum requirements of clause 303.7 of NZS 4223: Part 3 to comply with Acceptable Solution F2/AS1.

4.1.3 Glass design

Glass design shall be in accordance with NZS 4223: Part 1, 3 and 4 and Acceptable Solution B1/AS1 or specific engineering design to B1/VM1.

Note: *NZS 4223:Part 3:1999 Table 3.8 is based on NZS 4203 and should not be used because this Standard has been replaced by the Standard series AS/NZS 1170 in Clause B1 Structure. Use the loadings provided in Table 3.3 of this document.*

4.1.3.1 Insulating glass units (IGUs)

The inner glass shall be designed to meet the relevant barrier loads as defined in this guide, the human impact safety requirements and the load shared from wind loads.

The outer glass shall be designed to meet the load shared from wind loads and the human impact requirements, if applicable (refer NZS 4223: Part 3 Clause 303.6).

Note: *Human impact is not required on the outer pane if pedestrian access is restricted or not possible due to the height of the glazing above the floor or ground level.*

4.1.3.2 Holes in glass

Special attention should be given to stresses around fixing holes as these are often much higher than stresses away from the holes. These stresses may be determined using finite element analysis (FEA) or measured using strain gauges. Figure 4.1 shows a typical finite element analysis of stress concentrations around a hole.

Figure 4.1 Typical stress concentrations around holes in glass barriers

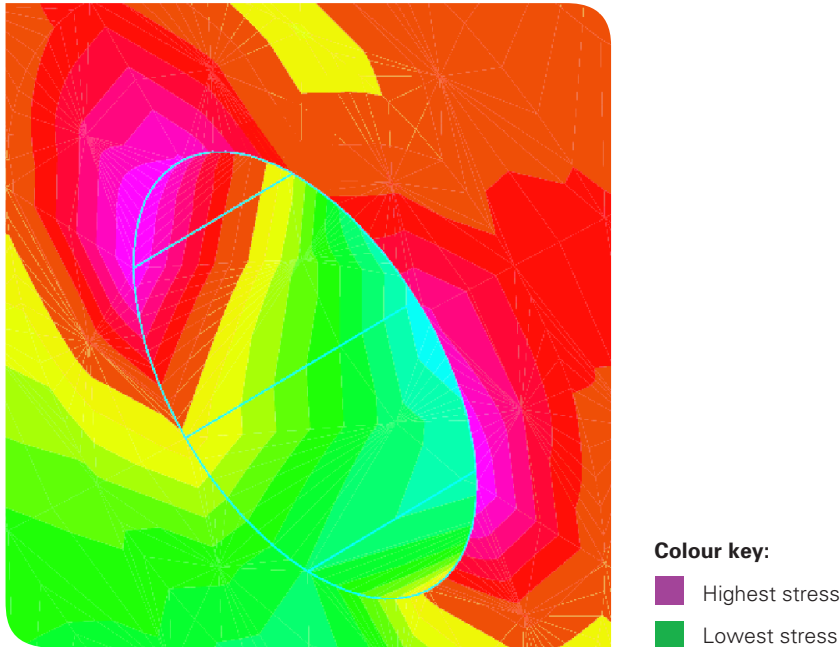

4.1.4 Glass barrier types (balustrades)

4.1.4.1 Screens and full-height glass barriers

Glass screens over 1500mm high and full-height glass acting as a barrier safeguarding against a fall of one metre or more shall meet the design criteria set out in Section 3.4.

Fully-framed glazing screens and full-height glass barriers, (such as building facades) shall comply with Figure 4.2, reproduced with permission of the Glass Association of New Zealand (GANZ).

Partly-framed, full-height glazing safeguarding against a fall of one metre or more should comply with Table 4.1A or Table 4.1B, reproduced with permission of the Glass Association of New Zealand (GANZ Table FH-1 and FH-2).



Figure 4.2 Fully-framed glazing safeguarding against a fall of one metre or more

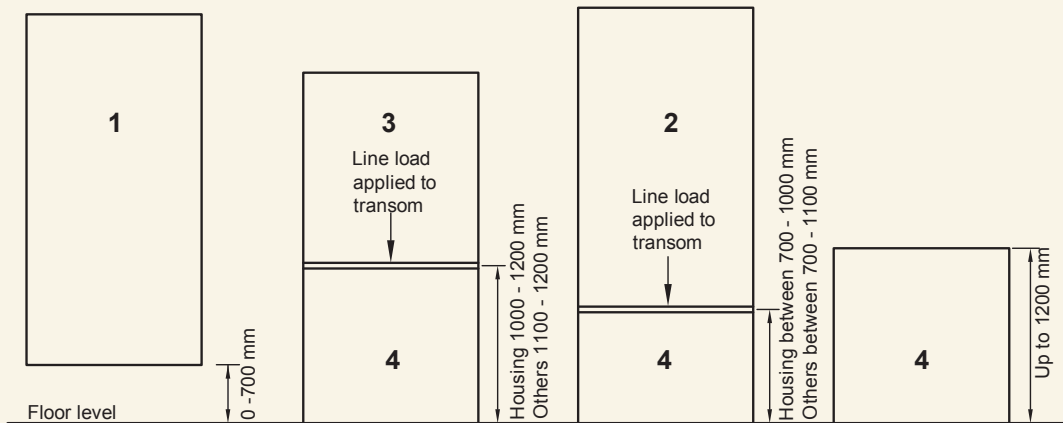

	Glass pane 1	Glass pane 2	Glass pane 3	Glass pane 4
Occupancy	Designed to infill uniform and concentrated load at 1200mm	Designed to infill uniform and concentrated load at 1200mm	Designed to wind pressures	Designed to infill uniform and concentrated load at centre
A (within private dwelling)	Safety glass to Table 3.1. Minimum 6mm toughened or annealed laminated glass	Safety glass to Table 3.1 or annealed glass to column 3 Table 3.2. Minimum 5mm thick	Specified or NZS 4223:4:2008 wind pressure	Balustrade Table 4.2
A (other) & C3 B, E	Safety glass to Table 3.1. Minimum 6mm toughened or 8mm annealed laminated glass	Safety glass to Table 3.1 or annealed glass to column 2 Table 3.2. Minimum 6mm thick	Specified or NZS 4223:4:2008 wind pressure	Balustrade Table 4.2
C1/C2, D & C5	Toughened or toughened laminated glass to Table 3.1. Minimum 6mm thick	Toughened or toughened laminated safety glass to Table 3.1. Minimum 6mm thick	Specified or NZS 4223:4:2008 wind pressure	Balustrade Table 4.2

Notes:

1. Infill, uniform and concentrated loads from Table 3.3 of AS/NZS 1170.1:2002 are applied as per B1/VM1
2. Top edge line and concentrated design loads are not applied to glass
3. Wind pressure on glazing must also be considered as this may be the worst load for design
4. For insulated glass units, the type and thickness of the inner glass pane should comply with this table
5. Tables 3.1 and 3.2 referred to in the table above are those in NZS 4223:Part 3:1999

Table 4.1A Full-height, partly-framed glazing safeguarding against a fall of one metre or more – line, concentrated and uniform loads

AS/NZS 1170 Occupancy	SLS design load (multiply by 1.5 for ULS)			Maximum glass height (mm)							
				Toughened safety glass				Toughened laminated safety glass			
	Line kN/m	Concentrated kN	Uniform kPa	10	12	15	19	10	12	16	20
A	0.35	0.25	0.5	2200	2500	3000	3500	2200	2500	3100	3700
A (other) & C3	0.75	0.5	1.0	1850	2100	2500	2950	1850	2100	2600	3100
B,E	0.75	0.5	1.0	1850	2100	2500	2950	1850	2100	2600	3100
C1/C2, & D	1.5	1.5	1.5	-	-	-	2650	-	-	-	2800
C5	3	1.5	1.5	-	-	-	2350	-	-	-	2650

Notes

1. The top and bottom edges of glass are supported by continuous frame (recommended minimum edgecover 12mm or thickness of glass).
2. The side edges are unframed and silicone butt jointed, and glass panels are at least 1000mm wide. Side edges of end panels are framed.
3. The joints are at least 6mm wide and sealed with structural silicone.
4. The glazing frame is designed to Clauses B1 and B2 of the Building Code.
5. Do not use this table for glass supported by point fixings (stand-off, spider fittings etc).
6. For design short-term live loads are applied as follows:
 - line load is applied at 1200mm above the bottom edge of glass
 - uniform infill load is applied over whole area of glass.
 - concentrated load is applied at 1200mm above the bottom edge of glass at the edge.
7. Glass deflections are limited to height/60 to a maximum of 30mm.
8. Glass thicknesses are nominal thicknesses and can be used for toughened laminated glass excluding the interlayer.
9. If wind pressure exceeds the uniform load above, wind load assessment for two-edge supported glass must be carried out.
10. Design is in accordance with NZS 4223.1:2008, Clause B1, B1/VM1 based on minimum glass thicknesses.
11. Designers should determine the maximum anticipated seismic movement of the barrier and provide sufficient frame depth to accommodate and ensure the panels remain in the frame.

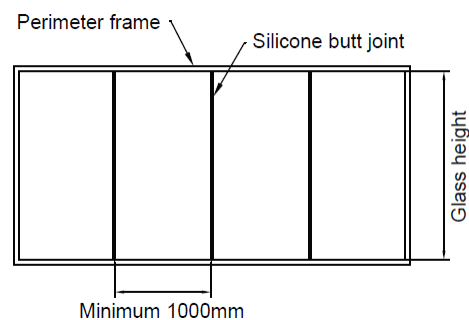
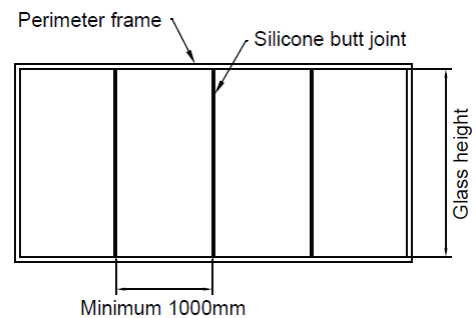

Table 4.1B Full-height, partly-framed glazing safeguarding against a fall of one metre or more – concentrated and uniform loads

AS/NZS 1170 Occupancy	SLS design load (multiply by 1.5 for ULS)			Maximum glass height (mm)							
				Toughened safety glass				Toughened laminated safety glass			
	Line kN/m	Concentrated kN	Uniform kPa	10	12	15	19	10	12	16	20
A	N/A	0.25	0.5	2400	2750	3200	3850	2400	2750	3400	4050
A (other) & C3	N/A	0.50	1.0	1950	2300	2900	3600	2000	2300	3050	3900
B,E	N/A	0.50	1.0	1950	2300	2900	3600	2000	2300	3050	3900
C1/C2, D & C5	N/A	1.5	1.5	-	1900	2250	2650	-	1900	2350	2800

Notes:

1. The top and bottom edges of the glass panels are supported by a continuous frame (recommended minimum edgecover 12mm or thickness of glass)
2. The side edges are unframed and silicone butt jointed, and glass panels are at least 1000mm wide. Side edges of end panels are framed.
3. The joints are at least 6mm wide and sealed with structural silicone.
4. The glazing frame and fixings are designed to Clauses B1 and B2 of the Building Code.
5. Do not use this table for glass supported by point fixings (stand-off, spider fittings etc).
6. For design of short-term infill, live loads are applied as follows:
 - 100% of the uniform infill load is applied up to 1200mm above the bottom edge of the glass, and 50% of uniform infill load applied from 1200mm to 2000mm.
 - concentrated infill load is applied at 1200mm above the bottom edge of the glass and at the edge.
7. Glass deflections are restricted to height/60 to a maximum of 30mm.
8. Glass thicknesses are nominal thicknesses and can be used for toughened laminated glass excluding the interlayer.
9. An ULS design wind pressure of 0.5 kPa is applied. If the wind pressure exceeds this or the uniform load above, wind load assessment for two-edge supported glass is required.
10. This design is in accordance with NZS 4223.1:2008, Clause B1, B1/VM1 based on minimum glass thicknesses.
11. Designers must determine the maximum anticipated seismic movement of the barrier and provide sufficient frame depth to accommodate and ensure the panels remain in the frame.



4.1.4.2 Glass Infill Barriers

Glass infill barriers are normally classified by the support provided to the glass edges, as follows:

Balustrade Infill – four-edge support

Balustrade Infill – two-edge support

Balustrade Infill – two-edge support – point fixed

Balustrade Infill – two-edge support – point fixed with handrail in front

Balustrade Infill – two-edge support - clamp fixed

Infill panels shall meet the design criteria for infill concentrated loads and uniform pressure loads.

Note: *Wind pressure on glazing must also be considered as this may be the worst load for design.*

For glass design, refer to Tables 4.2 to 4.6 reproduced with permission of the Glass Association of New Zealand (GANZ Tables IB-1 to IB-5).

Table 4.2 Balustrade infill – four-edge support

AS/NZS 1170 Occupancy	Design load (SLS)		Wind pressure		Maximum glass span (mm)						
	Concentrated kN	Uniform kPa	ULS kPa	SLS kPa	Laminated safety glass			Toughened safety glass		Toughened laminated safety glass	
					6	8	10	12	6	8 & over	8 & over
A	0.25	0.5	-	-	1000	1200	1200	1200	1200	1200	1200
A (other) & C3	0.5	1.0	2.1	1.5	-	1150	1200	1200	1100	1200	1200
B,E	0.5	1.0	2.1	1.5	-	1150	1200	1200	1100	1200	1200
C1/C2, C5 & D	1.5	1.5	2.1	1.5	-	-	-	480	700	1200	1200

Notes

- Four edges of the glass panel are supported by continuous frame or channel (recommended minimum edgecover 12mm).
- A structural handrail wider than 30mm in plan supported by posts is provided above the glass.
- The handrail, posts, bottom rail and glazing frame or channel are designed to the Building Code.
- Height of glass panel is not greater than 1200mm. Specific design is required for height exceeding this.
- Width of glass panel is not greater than 3000mm. Specific design is required for width exceeding this.
- Glass span is the smaller dimension of the height or width.
- Do not use this table for glass supported by point fixings (such as stand-off fittings). Stresses around holes must be checked for this type of installation.
- Glass spans have been calculated for short and medium term live loads using the minimum glass thickness and loads applied as follows:
 - Uniform load is applied over whole area of glass.
 - Concentrated load is applied at the centre the glass panel.
- Deflection of glass is limited to span/60 up to a maximum of 30mm excluding frame deflection.
- Glass thicknesses are nominal thicknesses and for toughened laminated glass exclude the interlayer.
- Glass thicknesses are based on the most severe load case.
- Design loads are in accordance with Building Code Compliance Document B1, B1/VM1 and AS/NZS 1170.
- For wind pressures exceeding the uniform pressures listed specific design is required.
- Ultimate design strength of glass is in accordance with NZS 4223.1:2008.
- Glass thicknesses for proprietary balustrade systems may be determined by specific design.
- Designers should determine the maximum anticipated seismic movement of the barrier and provide sufficient frame depth to accommodate and ensure the panels remain in the frame.

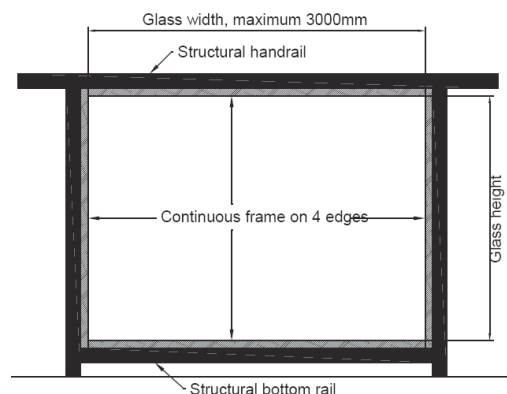

Table 4.3 Balustrade infill – two-edge support

AS/NZS 1170 Occupancy	Design load (SLS)		Wind pressure		Maximum glass span (mm)										
	Concentrated kN	Uniform kPa	ULS kPa	SLS kPa	Laminated safety glass		Toughened safety glass				Toughened laminated safety glass				
					10	12	6	8	10	12	15	8	10	12	16
A	0.25	0.5	-	-	750	1590	1380	1870	2200	2540	3000	1850	2200	2530	3140
A (other) & C3	0.5	1.0	2.1	1.5	-	-	-	1100	1650	1930	2250	1030	1600	1900	2380
B,E	0.5	1.0	2.1	1.5	-	-	-	1100	1650	1930	2250	1030	1600	1900	2380
C1/C2, C5 & D	1.5	1.5	2.1	1.5	-	-	-	-	-	450	1230	-	-	430	1550

Notes

- Two opposite edges of the glass panel are supported by continuous channel or frame (recommended minimum edgecover 12mm).
- A structural handrail wider than 30mm in plan supported by posts is provided above the glass.
- The handrail, posts and glazing frame are designed to the Building Code.
- The dimension between unsupported sides of the glass panel is at least 800mm wide.
- Do not use this table for glass supported by point fixings (such as stand-off fittings). Stresses around holes must be checked for this type of installation.
- Glass spans have been calculated for short and medium term live loads using the minimum glass thickness and loads applied as follows:
 - Uniform load is applied over whole area of glass.
 - Concentrated load is applied to the edge of glass panel at mid-span.
- Deflection of glass is limited to span/60 up to a maximum of 30mm excluding frame deflection.
- Glass thicknesses are nominal thicknesses and for toughened laminated glass exclude the interlayer.
- Glass thicknesses are based on the most severe load case.
- Design loads are in accordance with Building Code Compliance Document B1, B1/VM1 and AS/NZS 1170.
- For wind pressures exceeding those listed above specific design is required.
- Ultimate design strength of glass is in accordance with NZS 4223.1:2008.
- Glass thicknesses for proprietary balustrade systems may be determined by specific design.
- Designers should determine the maximum anticipated seismic movement of the barrier and provide sufficient frame depth to accommodate and ensure the panels remain in the frame.

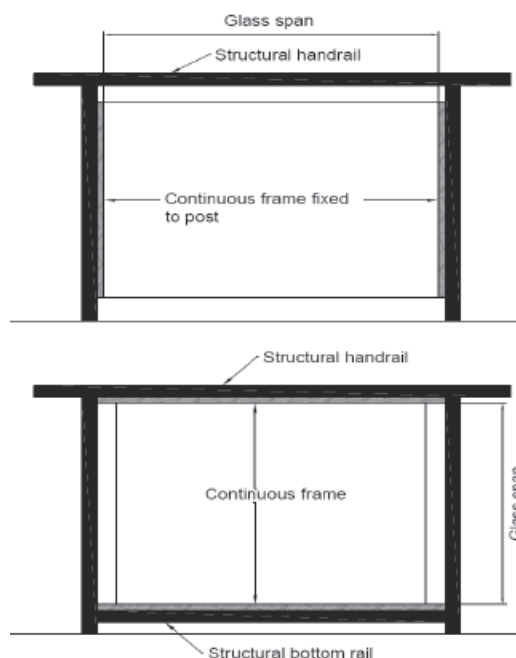

Table 4.4 Balustrade infill – two-edge, point fixed, structural handrail in front of glass

AS/NZS 1170 Occupancy	Design load (SLS)			Wind pressure		Maximum glass width (mm)							
	Line kN/m	Concentrated kN	Uniform kPa	ULS kPa	SLS kPa	Toughened safety glass				Toughened laminated safety glass			
						10	12	15	19	10	12	16	20
A	0.35	0.25	0.5	-	-	2050	2250	2600	2850	2050	2250	2700	2950
A (other) & C3	0.75	0.5	1.0	2.1	1.5	1350	1500	1650	1850	1350	1500	1700	1900
B,E	0.75	0.5	1.0	2.1	1.5	1350	1500	1650	1850	1350	1500	1700	1900
C1/C2, C5 & D	1.5	1.5	1.5	2.1	1.5	-	-	-	1300	-	-	-	1400
C5	3.0	1.5	1.5	2.1	1.5	-	-	-	1300	-	-	-	1400

Notes

- Two opposite edges of the glass panel are supported by steel fittings.
- Each edge is supported by at least 2 fittings located no further than 250mm from the top and bottom edges for occupancy A, B, E and C3, and 150mm for C1/C2, D and C5, and between 50 to 100mm in from the edge.
- Fittings are at least 50mm in diameter and 6mm thick placed on either side of the glass panel with hard gaskets and nylon bushes to prevent glass and metal contact.
- A structural handrail wider than 30mm in plan is provided in front of the glass not more than 200mm from the top edge.
- The handrail and fittings are supported by the posts.
- The posts, handrail and fittings are designed to the Building Code.
- Glass panels are at least 800mm high.
- Maximum glass width is the horizontal span between fittings plus 100mm.
- Glass widths have been calculated for short and medium term live loads using the minimum glass thickness and loads applied as follows:
 - 100% of the line load is applied to the structural handrail.
 - 50% of the line load is applied to top edge of glass.
 - Uniform load and wind pressure are applied over whole area of glass.
 - Concentrated load is applied at corner of glass panel, and at mid span along the edge.
- Deflection of glass is limited to span/60 up to a maximum of 30mm. This excludes movement of the supporting posts.
- Glass thicknesses are nominal thicknesses and for toughened laminated glass exclude the interlayer.
- Glass thicknesses are based on the most severe load case.
- Design loads are in accordance with Building Code Compliance Document B1, B1/VM1 and AS/NZS 1170.
- For wind pressures exceeding those listed above specific design is required.
- Ultimate design strength of glass is in accordance with NZS 4223.1:2008.
- Glass thicknesses for proprietary balustrade systems may be determined by specific design.

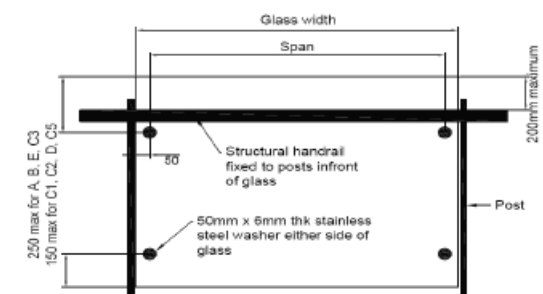

Table 4.5 Balustrade infill – two-edge, point fixed

AS/NZS 1170 Occupancy	Design load (SLS)		Wind pressure		Maximum glass width (mm)							
	Concentrated kN	Uniform kPa	ULS kPa	SLS kPa	Toughened safety glass				Toughened laminated safety glass			
					10	12	15	19	10	12	16	20
A	0.25	0.5	-	-	2050	2250	2600	2850	2050	2250	2700	2950
A (other) & C3	0.5	1.0	2.1	1.5	1350	1500	1650	1850	1350	1500	1700	1900
B,E	0.5	1.0	2.1	1.5	1350	1500	1650	1850	1350	1500	1700	1900
C1/C2, C5 & D	1.5	1.5	2.1	1.5	-	-	-	1300	-	-	-	1400
C5	1.5	1.5	2.1	1.5	-	-	-	1300	-	-	-	1400

Notes

- Two opposite edges of the glass panel are supported by steel fittings.
- Each edge is supported by at least 2 fittings located no further than 250mm from the top and bottom edges for occupancy A, B, E and C3, and 150mm for C1/C2, D and C5, and between 50 to 100mm in from the edge.
- Fittings are at least 50mm in diameter and 6mm thick placed on either side of the glass panel with hard gaskets and nylon bushes to prevent glass and metal contact.
- A structural handrail wider than 30mm in plan is provided above the glass.
- The handrail and fittings are supported by posts.
- The posts, handrail and fittings are designed to the Building Code.
- Glass panels are at least 800mm high.
- Maximum glass width is the horizontal span between fittings plus 100mm.
- Glass widths have been calculated for short and medium term live loads using the minimum glass thickness and loads applied as follows:
 - 100 % of the line load is applied to the structural handrail.
 - Uniform load and wind pressure are applied over whole area of glass.
 - Concentrated load is applied at corner of glass panel, and at mid-span along the edge.
- Deflection of glass is limited to span/60 up to a maximum of 30mm. This excludes movement of the supporting posts.
- Glass thicknesses are nominal thicknesses and for toughened laminated glass exclude the interlayer.
- Glass thicknesses are based on the most severe load case.
- Design loads are in accordance with Building Code Compliance Document B1, B1/VM1 and AS/NZS 1170.
- For wind pressures exceeding those listed above specific design is required.
- Ultimate design strength of glass is in accordance with NZS 4223.1:2008.
- Glass thicknesses for proprietary balustrade systems may be determined by specific design

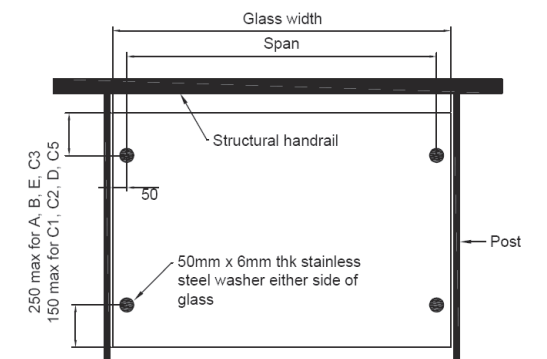
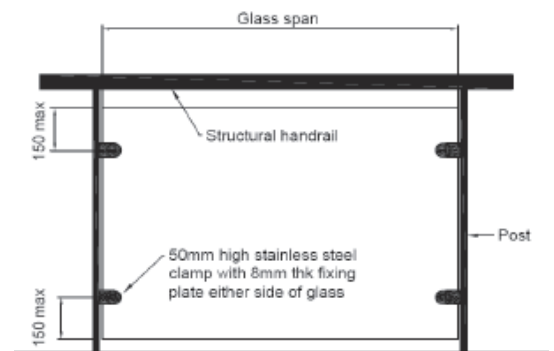

Table 4.6 Balustrade infill – two-edge, clamped (no holes in glass)

AS/NZS 1170 Occupancy	Design load (SLS)		Wind pressure		Maximum glass span (mm)			
	Concentrated kN	Uniform kPa	ULS kPa	SLS kPa	Toughened safety glass		Toughened laminated safety glass	
					10	12	10	12
A	0.25	0.5	-	-	2100	2300	2100	2300
A (other) & C3	0.5	1.0	2.1	1.5	1450	1700	1400	1650
B,E	0.5	1.0	2.1	1.5	1450	1700	1400	1650
C1/C2, C5 & D	1.5	1.5	2.1	1.5	-	-	-	-
C5	1.5	1.5	2.1	1.5	-	-	-	-

Notes

- Two opposite edges of the glass panel are supported by stainless steel clamps without holes in glass.
- Each edge is supported by at least 2 clamps located no further than 150mm from the top and bottom edges.
- Clamps are at least 50mm high with 8mm thick fixing plates on either side of glass panel and gasket to prevent glass and metal contact. Glass to be clamped at least 40mm in from the edge.
- A set of 4 clamps should be able to support a weight of 100 kg. Glass width should not exceed the manufacturer's limitation.
- A structural handrail wider than 30mm in plan is provided above the glass.
- The posts, handrail and clamps are designed to the Building Code.
- Glass panels are at least 800mm high.
- Glass spans have been calculated for short and medium term live loads using the minimum glass thicknesses and loads applied as follows:
 - 100 % of the line load is applied to the structural handrail.
 - Uniform load and wind pressure are applied over whole area of glass.
 - Concentrated load is applied at corner of glass panel, and at mid-span along the edge.
- Deflection of glass is limited to span/60 up to a maximum of 30mm. This excludes movement of the supporting posts.
- Glass thicknesses are nominal thicknesses and for toughened laminated glass exclude the interlayer.
- Glass thicknesses are based on the most severe load case.
- Design loads are in accordance with Building Code Compliance Document B1, B1/VM1 and AS/NZS 1170.
- For wind pressures exceeding those listed above specific design is required.
- Ultimate design strength of glass is in accordance with NZS 4223.1:2008.
- Glass thicknesses for proprietary balustrade systems may be determined by specific design.



4.1.4.3 Structural glass barriers

Structural glass barriers use glass as a structural element and are normally classified by the following types:

- Structural Balustrade - cantilevered glass
- Structural Balustrade – two-edge point fixed
- Structural Balustrade – two-edge support
- Structural Balustrade – three-edge support

Structural balustrades shall meet the design criteria for top edge line and point loads and infill uniform pressures and point loads.

All Structural Glass Barriers shall have interlinking rails unless one or more of the following apply:

- (a) the entire glass panel is less than 5m from the finished floor, deck or ground level directly below the barrier (see Notes 1 and 4)
- (b) the barrier is heat strengthened or toughened laminated safety glass with a top edge rail or capping to protect the top edge from dual pane fracture (see Notes 2 and 3)
- (c) the barrier is heat strengthened or toughened laminated safety glass and has two- or three-edge supported by a structural sealant joint or continuous clamp, or other means to hold the glass in place in case of dual pane fracture (see Notes 2 and 3)
- (d) the barrier is designed using heat strengthened or toughened laminated safety glass with an interlayer that prevents collapse in the case of dual-pane breakage. (Note 5)

Note:

1. *This overcomes the concern of toughened glass particles falling from a great height and aligns with the sloped and overhead glazing requirements of NZS 4223.1:2008.*
2. *If both panes are broken, toughened laminated glass can collapse like a “wet blanket” and fall from the opening in one piece, depending on the support method.*
3. *Laminated glass is susceptible to minor edge de-lamination, depending on the interlayer and laminating process. Normally this will not affect the mechanical properties but may be noticeable on exposed edges.*
4. *Heat soaking is recommended for monolithic toughened glass used in structural glass barriers as provided by Tables 4.7 to 4.10.*
5. *The barrier shall remain intact after a 46kg swing bag test released from a height of 1200mm above the centre of the barrier section and impacting the middle of the barrier. This test aligns with AS/NZS 2208:1996 and guidance provided in ASTM 2353.*

For glass design refer to Tables 4.7 to 4.10 reproduced with permission of the Glass Association of New Zealand (GANZ Tables SB-1 to SB-4).

Note: *Wind pressure on glazing must also be considered as this may be the worst load for design.*



Table 4.7 Structural balustrade infill – cantilevered glass

AS/NZS 1170 Occupancy	Design load (SLS)			Wind pressure		Maximum glass height (mm)							
	Line kN/m	Concentrated kN	Uniform kPa	ULS kPa	SLS kPa	Toughened safety glass				Toughened laminated safety glass			
						10	12	15	19	10	12	16	20
A	0.35	0.6	0.5	-	-	550	1030	1500	2020	600	1000	1780	2130
A (other) & C3	0.75	0.6	1.0	2.1	1.5	550	1030	1300	1530	600	1000	1360	1620
B,E	0.75	0.6	1.0	2.1	1.5	550	1030	1300	1530	600	1000	1360	1620
C1/C2, D	1.5	1.5	1.5	2.1	1.5	-	-	-	880	-	-	400	1150
C5	3.0	1.5	1.5	2.1	1.5	-	-	-	680	-	-	400	800

Notes

1. The base of the glass is supported by a continuous rigid clamp or channel designed to the Building Code.
2. Glass panels are at least 1000mm wide unless connected by an interlinking handrail.
3. Heights are measured from base of top-fixed channel or clamp to top of glass, and from top of grout for glass grouted into a concrete recess.
4. Do not use this table for glass supported by point fixings (such as stand-off fittings). Stresses around holes must be checked for this type of installation.
5. Glass heights have been calculated for short and medium term live loads using the minimum glass thickness and loads applied as follows:
 - Line loads are applied to top edge of glass or at 1200mm if glass is higher than 1200mm.
 - Uniform load and wind pressure are applied over whole area of glass.
 - Concentrated load is applied to top corner of glass panel. If glass is higher than 1200mm load is applied at 1200mm with 50% applied to the top corner.
6. Deflection of glass is limited to 30 mm excluding rotation of channel or clamp.
7. Glass thicknesses are nominal thicknesses and for toughened laminated glass exclude the interlayer.
8. Glass thicknesses are based on the most severe load case.
9. Design loads are in accordance with Building Code Compliance Document B1, B1/VM1 and AS/NZS 1170.
10. For wind pressures exceeding those listed specific design is required.
11. Ultimate design strength of glass is in accordance with NZS 4223.1:2008.
12. Glass thicknesses for proprietary balustrade systems may be determined by specific design.

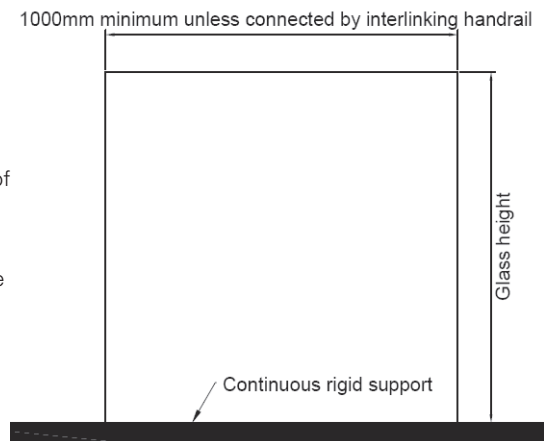

Table 4.8 Structural balustrade – two-edge point fixed

AS/NZS 1170 Occupancy	Design load (SLS)			Wind pressure		Maximum glass width (mm)							
	Line kN/m	Concentrated kN	Uniform kPa	ULS kPa	SLS kPa	Toughened safety glass				Toughened laminated safety glass			
						10	12	15	19	10	12	16	20
A	0.35	0.6	0.5	-	-	1550	1850	2550	2080	1450	1800	2650	2950
A (other) & C3	0.75	0.6	1.0	2.1	1.5	1200	1350	1600	1850	1150	1300	1700	1950
B,E	0.75	0.6	1.0	2.1	1.5	1200	1350	1600	1850	1150	1300	1700	1950
C1/C2, D	1.5	1.5	1.5	2.1	1.5	-	-	-	1300	-	-	-	1400
C5	3.0	1.5	1.5	2.1	1.5	-	-	-	750	-	-	-	850

Notes

- Two opposite edges of the glass panel are supported by steel fittings.
- Each edge is supported by at least 2 fittings located no further than 150mm from the top and bottom edges, and between 50 to 100mm in from the edge.
- Fittings are at least 50mm in diameter and 6mm thick placed on either side of the glass panel with hard gaskets and nylon bushes to prevent glass and metal contact.
- The fittings are supported by posts designed to the Building Code.
- Glass panels are at least 800mm high.
- Maximum glass width is the horizontal span between fittings plus 100mm.
- Glass widths have been calculated for short and medium term live loads using the minimum glass thickness and loads applied as follows:
 - Line loads are applied to top edge of glass.
 - Uniform load and wind pressure are applied over whole area of glass.
 - Concentrated load is applied at corner of glass panel, or at mid-span along the edge.
- Deflection of glass is limited to $\text{span}/60$ up to a maximum of 30mm. This excludes movement of the supporting posts.
- Glass thicknesses are nominal thicknesses and for toughened laminated glass exclude the interlayer.
- Glass thicknesses are based on the most severe load case.
- Design loads are in accordance with Building Code Compliance Document B1, B1/VM1 and AS/NZS 1170.
- For wind pressures exceeding those listed above specific design is required.
- Ultimate design strength of glass is in accordance with NZS 4223.1:2008.
- Glass thicknesses for proprietary balustrade systems may be determined by specific design.

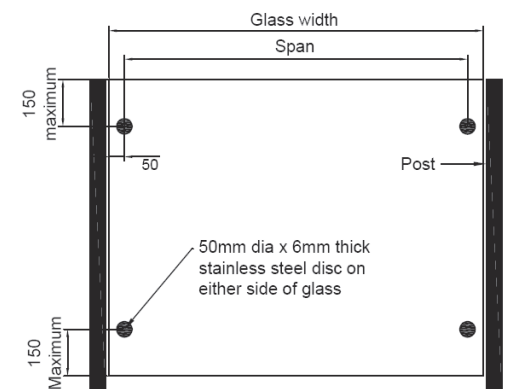

Table 4.9 Structural balustrade – two-edge support

AS/NZS 1170 Occupancy	Design load			Wind pressure		Maximum glass span(mm)									
	Line kN/m	Concentrated kN	Uniform kPa	ULS kPa	SLS kPa	Toughened safety glass					Toughened laminated safety glass				
						8	10	12	15	19	8	10	12	16	20
A	0.35	0.6	0.5	-	-	650	1650	2450	3000	3500	610	1600	2430	3100	3700
A (other) & C3	0.75	0.6	1.0	2.1	1.5	650	1650	1930	2250	2650	610	1600	1900	2380	2800
B,E	0.75	0.6	1.0	2.1	1.5	650	1650	1930	2250	2650	610	1600	1900	2380	2800
C1/C2, D	1.5	1.5	1.5	2.1	1.5	-	-	450	1200	1750	-	-	430	1500	2580
C5	3.0	1.5	1.5	2.1	1.5	-	-	450	1200	1750	-	-	430	1450	1900

Notes

- Two opposite edges of the panel are supported by continuous channel or frame (recommended minimum edgecover 12mm).
- The channels, frames and posts are designed to the Building Code.
- Glass panels are at least 800mm high.
- Glass spans have been calculated for short and medium term live loads using the minimum glass thickness and loads applied as follows:
 - Line loads are applied to top edge of glass.
 - Uniform load and wind pressure are applied over whole area of glass.
 - Concentrated load is applied at mid-span along the edge.
- Deflection of glass is limited to span/60 up to a maximum of 30mm. This excludes movement of the supporting posts.
- Glass thickness are nominal thickness and for toughened laminated glass exclude the interlayer.
- Glass thickness are based on the most severe load case.
- Design loads are in accordance with the Building Code Compliance Document B1, B1/VM1 and AS/NZS 1170.
- For wind pressures exceeding those listed above specific design is required.
- Ultimate design strength of glass is in accordance with NZS 4223. 1:2008.
- Glass thickness for proprietary balustrade systems may be determined by specific design.
- Designers should determine the maximum anticipated seismic movement of the barrier and provide sufficient frame depth to accommodate and ensure the panels remain in the frame.

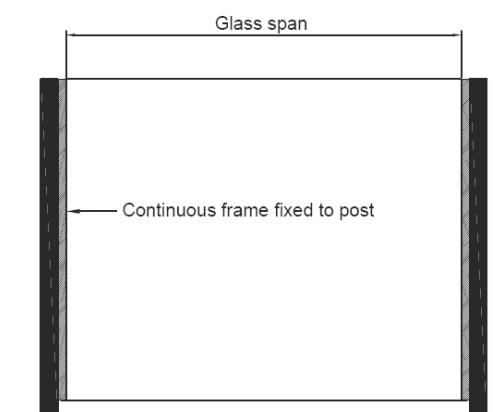
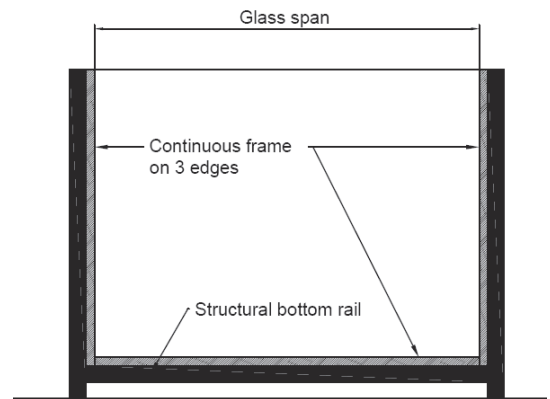

Table 4.10 Structural balustrade – three-edge support

AS/NZS 1170 Occupancy	Design load (SLS)			Wind pressure		Maximum glass span (mm)							
	Line kN/m	Concentrated kN	Uniform kPa	ULS kPa	SLS kPa	Toughened safety glass				Toughened laminated safety glass			
						8	10	12	15	8	10	12	16
A	0.35	0.6	0.5	-	-	650	2590	3350	3900	610	2570	3300	3900
A (other) & C3	0.75	0.6	1.0	2.1	1.5	650	1900	2300	2850	610	1900	2300	3050
B,E	0.75	0.6	1.0	2.1	1.5	650	1900	2300	2850	610	1900	2300	3050
C1/C2, D	1.5	1.5	1.5	2.1	1.5	-	-	450	1350	-	-	450	1550
C5	3.0	1.5	1.5	2.1	1.5	-	-	450	1350	-	-	450	1550

Notes

- Two opposite and bottom edges of the glass panel are supported by continuous frame or channel (recommended minimum edgecover 12mm).
- The posts, bottom rail and glazing frame or channel are designed to the Building Code.
- Glass spans have been calculated for short and medium term live loads using the minimum glass thickness and loads applied as follows:
 - Line loads are applied to top edge of glass.
 - Uniform load and wind pressure are applied over whole area of glass.
 - Concentrated load is applied at mid-span along the top edge.
- Deflection of glass is limited to span/60 up to a maximum of 30mm. This excludes movement of the supporting posts and bottom rail.
- Glass thicknesses are nominal thicknesses and for toughened laminated glass exclude the interlayer.
- Glass thicknesses are based on the most severe load case.
- Design loads are in accordance with Building Code Compliance Document B1, B1/VM1 and AS/NZS 1170.
- For wind pressures exceeding those listed above specific design is required.
- Ultimate design strength of glass is in accordance with NZS 4223.1:2008.
- Glass thicknesses for proprietary balustrade systems may be determined by specific design.
- Designers should determine the maximum anticipated seismic movement of the barrier and provide sufficient frame depth to accommodate and ensure the panels remain in the frame.



4.1.4.4 Glass fences

Glass fences, including swimming pool fences, that safeguard against a fall of one metre or more are also barriers and shall comply with the barrier design criteria in Section 3 and this section.

Note. Wind pressure on glazing must also be considered as this may be the worst load for design.

4.1.4.5 Glass combination barriers

Barriers using a combination of infill and structural elements are subject to specific design using the barrier design criteria in Section 3 of this guide and NZS 4223:Part 1.

4.1.5 Rails and handrails

Rails and handrails are defined in Section 1.

For handrail requirements in relation to accessible routes, refer to paragraph 6.0 of Acceptable Solution D1/AS1.

When handrails are fixed directly to glass through holes in the glass, they can cause localized stress in the glass and the designer shall ensure the fixing type and hole centres are adequate to support the design criteria. (See Section 4.1.3.2)

4.1.6 Working on glass

All shape cutting, edgework, hole drilling and notches shall be undertaken prior to installation and prior to toughening, if toughened glass is required.

Notches and holes shall not be used in annealed laminated glass. (See Section 4.1.3.2)

4.1.7 Installation

Contact between glass and any other hard material (including other glass parts) shall be avoided. Wedges, backing seals, glazing tapes, gaskets or sealants shall be used to prevent glass to metal contact.

The supporting frame sections should have a minimum edge cover of 12mm for two- and three-edge support and four-edge support should comply with NZS 4223.1 Table 5.

When bolted or point fixings are used, the holes shall have inserts of incompressible bushes normally 2 - 5mm thickness (1mm min).

For clamping plates or discs, hard fibre or plastic gaskets (0.5mm minimum thickness) shall be used. Clamp fixings shall be a minimum of 50mm square or circular and 6mm thick, unless testing or specific design can show that the stresses around the holes are not excessive.

The frame and/or fixings shall be designed not to distort the glass panel and put undue stress in the glass.

4.1.8 Maintenance

All glass panels should be regularly cleaned and fixing should be checked for loosening, gasket deterioration and corrosion.

Regular washing and drying of glass affects long-term durability, especially during construction. The most important operation is to dry the glass after washing using a clean grit-free squeegee, cloth or paper towel.

Grease marks or glazing compounds and sealant should be removed before washing, which is best done out of direct sunlight using proprietary cleaners or soapy water.

Suggested maintenance schedule:

- Construction sites – check weekly for build-up and clean every one to two months
- Industrial sites – Clean every one to two months
- Urban areas – Clean every three months
- Rural areas – Clean every six months unless crop spraying or sprinkling with bore water

4.1.9 Typical fixing details

Typical fixing details for glass barriers are shown in Figures 4.3 to 4.7 following.

Figure 4.3 Glass fixed with disc fitting to metal tab

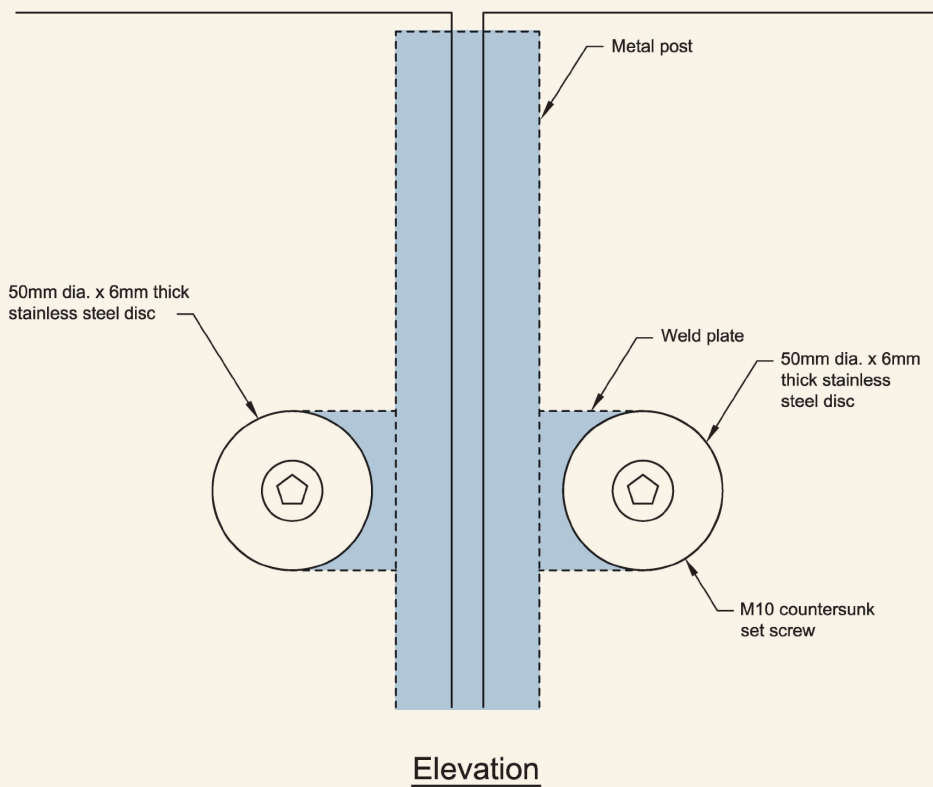
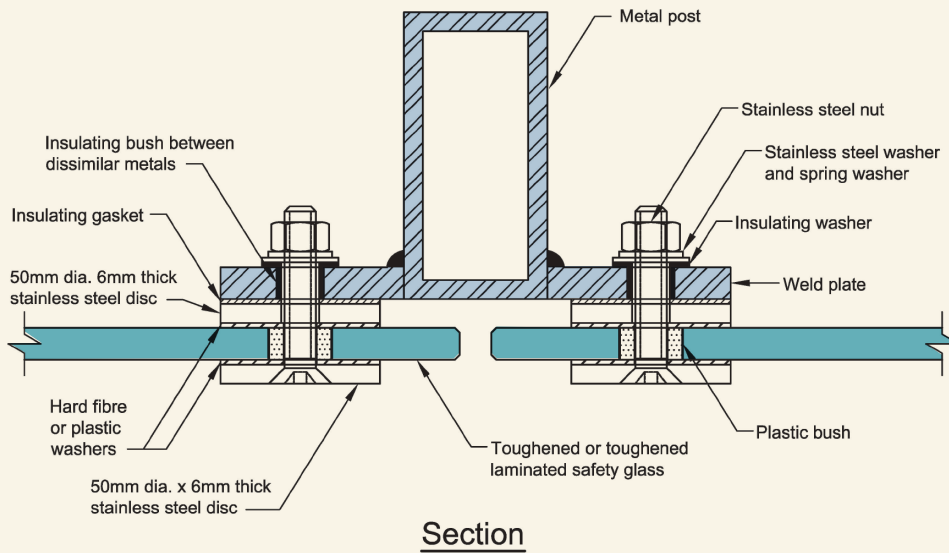

Figure 4.4 Glass fixed with spider fitting to post

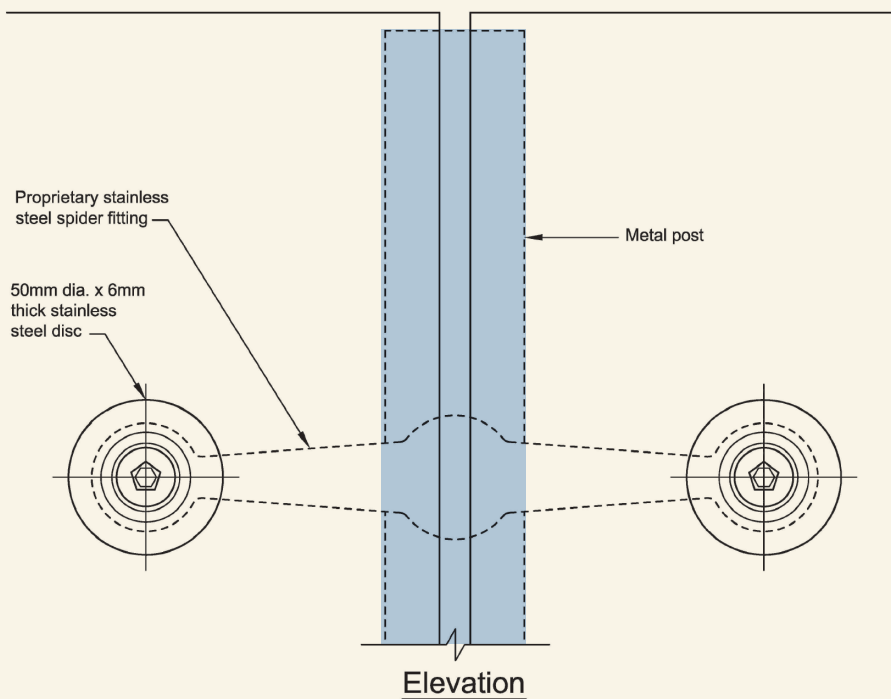
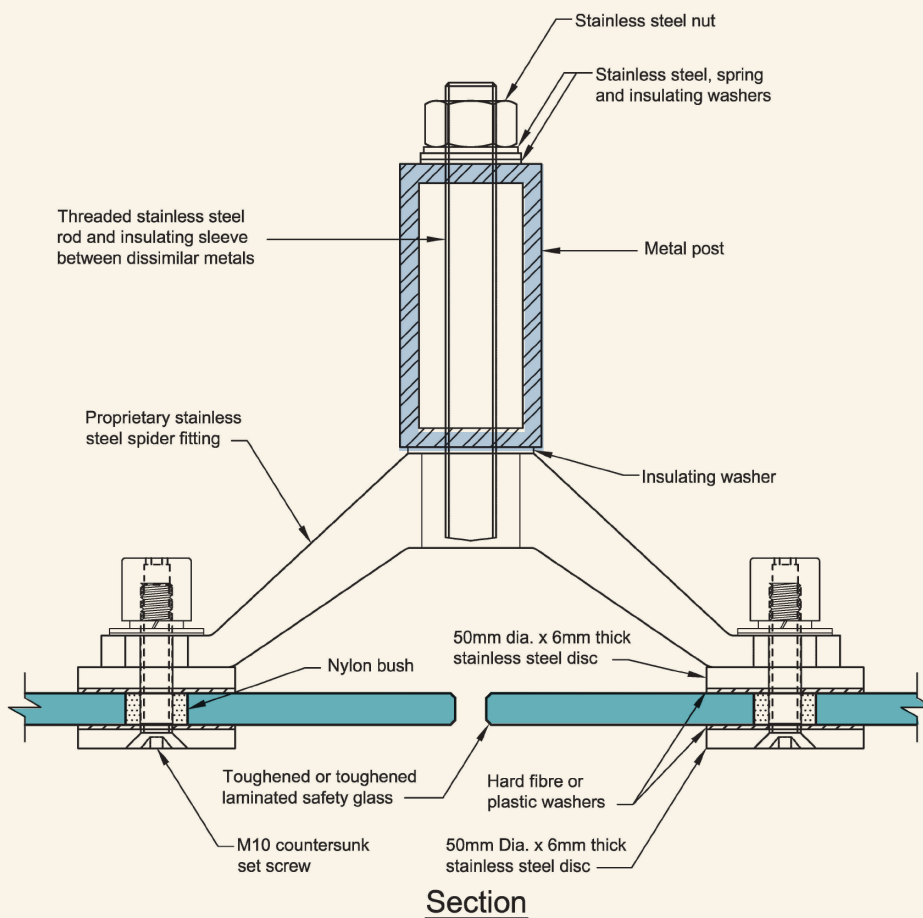

Figure 4.5 Glass cantilever fixed with double disc fitting to concrete

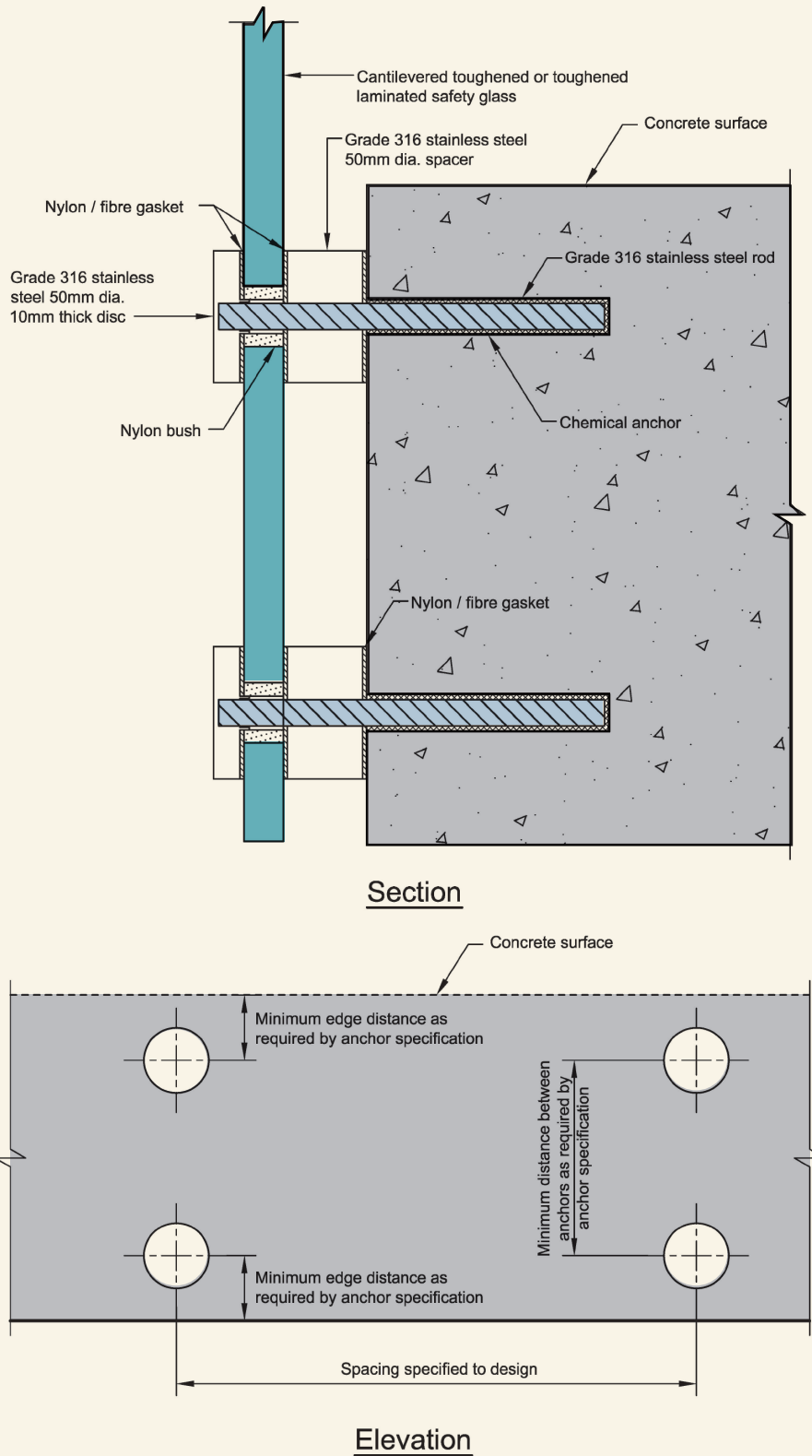

Figure 4.6 Glass cantilever fixed with clamp plate to steel beam

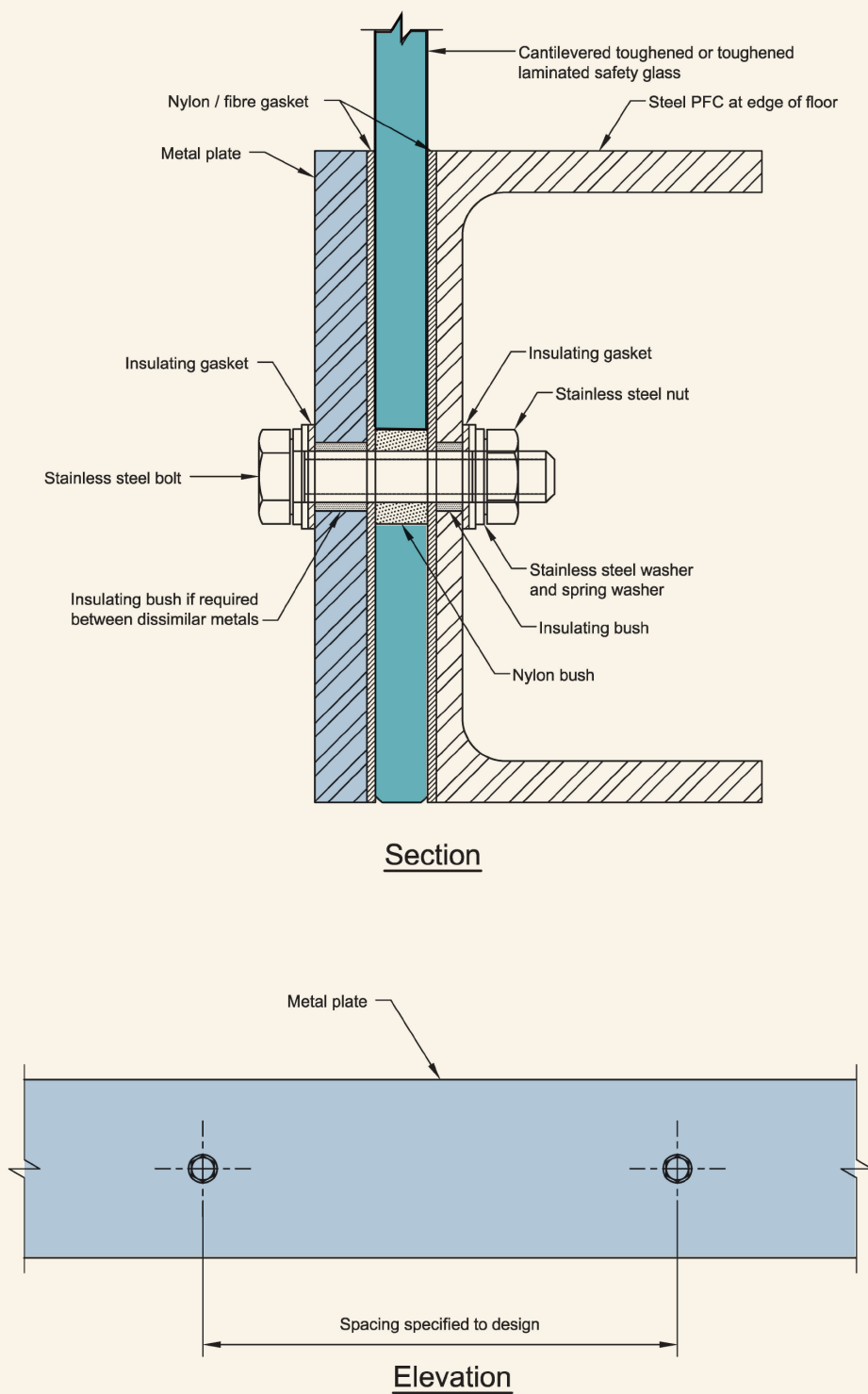
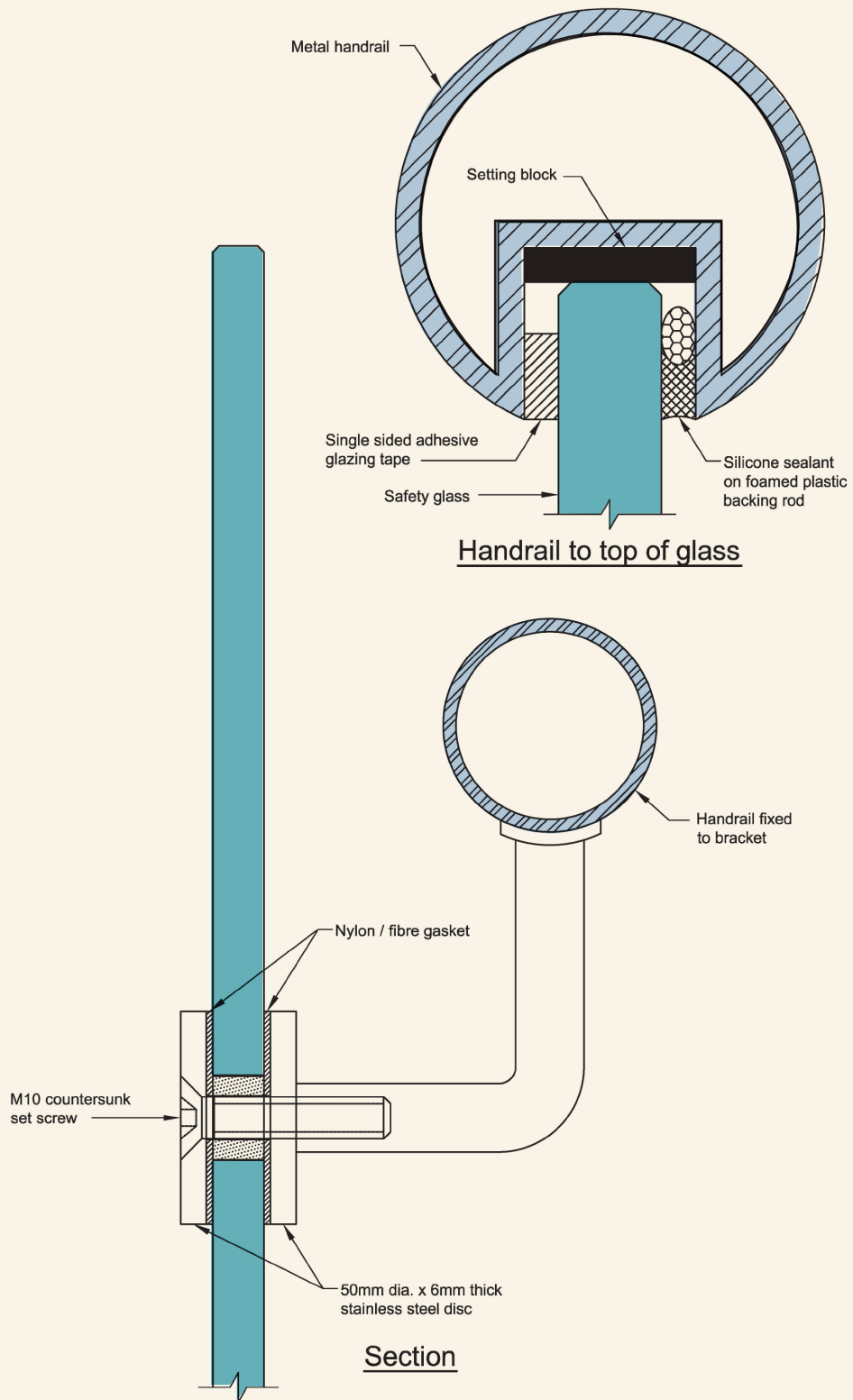

Figure 4.7 Handrail fittings to glass



4.2 Timber

4.2.1 Materials

Timber used for barriers should comply with the species and grades described in NZS 3603:1993: Timber Structures Standard.

4.2.2 Design

General

The design of all timber barriers should be in accordance with NZS 3603: 1993: Timber Structures Standard.

Using the design criteria given in Section 3 of this guide, the stresses used in the design must be appropriate for the grade of timber selected. The minimum imposed actions from Table 3.2 should be considered to be of brief duration as defined in Table 2.4 of NZS 3603:1993.

For external barriers that are not enclosed or clad to prevent the ingress of moisture, the characteristic timber stresses used in the design of the barrier should be those for green timber, i.e. where the in-service moisture contents are likely to be 25% or over.

Joints

All joints in the timber should be designed in accordance with NZS 3603:1993.

Where proprietary fixings are proposed it is important to ensure the joints are designed in accordance with the manufacturer's instructions and technical guidance, taking into account such things as: timber strength, fixing embedment, fixing centres, fixing durability, edge distances and whether the capacities quoted are working stress loads or ultimate strength values.

4.2.3 Fabrication

Moisture content

The moisture content of the timber should, as far as reasonably practical, be appropriate to the position in which it is to be used.

Preparation of timber

The surface finish to all barriers should be smooth and clear of any projections that would cause injury. All sharp edges should be removed to reduce splintering. Handrails should be smooth finished and of a type of timber not liable to produce splinters in use.

Assembly

The components of barriers should be connected to each other using the methods recommended in NZS 3603:1993. Trial assemblies of prefabricated barriers are recommended.



4.2.4 Durability/treatment

All timber used in barriers must meet the durability requirements of Clause B2 of the NZBC. This can be achieved by complying with NZS 3602:2003: Timber and Wood-based Products for Use in Building with the modifications set out in Acceptable Solution B2/AS1.

All metal fixings must also be designed to meet the durability requirements of Clause B2. Care is required to ensure there are no incompatibilities between the metal fixings (including coating systems) and the preservatives used in the treatment of the timber members.

For external timber barriers where fixings are used in contact with timber treated with Copper Azole or Alkaline Copper Quaternary (ACQ) preservatives, the fixings shall be Type 304 stainless steel. For further details, refer to clause 4.4.4 of NZS 3604: 2011 Timber-framed buildings.

4.2.5 Installation

Care should be taken to avoid overstressing of members during fixing. All site bolted joints should be inspected and all bolts should be carefully tightened without crushing the wood under washers. All metal fixings should be protected from corrosion.

4.2.6 Maintenance

The periodic cleaning and the renewal of certain finishes is necessary to maintain the durability of the barrier system. All joints and connections should be checked for movement within the joints. Screws, nails and bolts should be checked for corrosion.

4.2.7 Timber barrier design for residential and domestic buildings

4.2.7.1 Scope

This design applies to the construction of timber barriers for residential and domestic buildings. The design will have an expected life in accordance with Acceptable Solution B2/AS1 Table 1, i.e. 50 years for the supporting structure, structural posts and handrail, and 15 years for the infill (palings and rails).

This design solution will satisfy the requirements of NZBC Clause F4 for the protection of children under the age of six years.

All timber used should be grade SG8 (wet) (MSG8 and VSG8), except for the palings which can be SG6 (No. 1 Framing).

Cross-sectional dimensions noted are the actual finished sizes of the timber.

Barriers should have:

- all timber preservative treatment complying with NZS 3602: 2003.
- metal fixings and fasteners complying with section 4.4 of NZS 3604: 2011.

4.2.7.2 Construction

General

A barrier may comprise structural posts, handrail, top and bottom rails and palings. The supporting structure should be in accordance with section 7.4 of NZS 3604:2011.

Handrail

The 90mm x 45mm handrail should be fixed with four 100mm x 3.75mm nails to the top of each structural post as shown in Figure 4.8. At the locations of handrail joins there should be two nails in each handrail connected to the structural post.

Structural Posts

The 90mm x 90mm structural posts should be fixed to either a double end joist or to a double boundary joist. The two situations are shown in Figure 7.10(c) of NZS 3604:2011.

Where a structural post is fixed to an end joist or a boundary joist, it should be fixed with two M12 bolts as shown in Figure 4.8. The structural post should be positioned in accordance with Figure 7.10(c) of NZS 3604:2011.

Figure 4.8 Structural post to joist connection

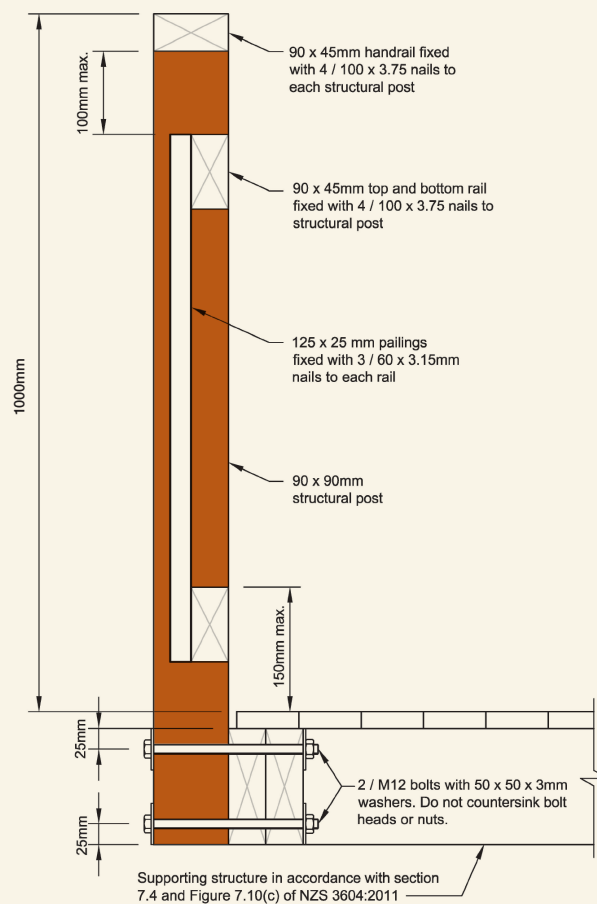

Top and Bottom Rails

The top and bottom rails span between the structural posts and should be 90mm x 45mm. Where the rails are cut between the structural posts the rails should be fixed at each end with four skewed 100mm x 3.75mm nails. It is also acceptable to fix the rails to either the inner or outer faces of the structural posts. In these instances, the rails should be fixed to either the inner or outer faces of each structural post with four 100mm x 3.75mm nails.

Palings

Palings should be 125mm x 25mm timbers spanning between the top and bottom rails. Palings are to be installed with a maximum gap between palings of 100mm.

Palings are to be connected to both the top and bottom rails. Each connection of the paling to the top and bottom rail should have three 60mm x 3.15mm nails. Palings may be fixed to either side of the rails.

Note: *Other infills may be used in conjunction with the structural posts and handrails detailed here, but the infill and its connections will require specific design.*

4.3 Metals

4.3.1 General

This section provides guidance on the most common metals used in barriers and relates to the fabrication, corrosion protection and installation of metal barriers. Where the barrier contains a glass panel infill, refer to section 4.1.

This guidance may be suitable for other metals not covered in this guide, subject to the provision of additional research and investigation.

4.3.2 Aluminium

Aluminium barriers should be designed in accordance with AS/NZS 1664.1:1997 or tested to comply with AS/NZS 1170.0:2002 Appendix B.

Corrosion resistance

Aluminium has good corrosion resistance. This is due to the oxide film that bonds strongly to its surface and, if damaged, re-forms quickly in most environments. Aluminium's durability can be improved further by anodizing.

Anodizing

The anodizing process involves passing a controlled electrical current through extruded aluminium profiles immersed in an acidic (sulphuric) solution, which forms a protective film of aluminium oxide on the surface of the aluminium. The protection of the aluminium section improves as the thickness of the anodizing increases. Typical thicknesses of anodizing for different environmental conditions are shown below:

- 12 microns – sheltered, non-coastal areas including internal environments
- 20 microns – exposed and inland areas (minimum recommended for balustrades/barriers)
- 24 microns – coastal and geothermal areas

AAMA 611-98 – Voluntary Standards for Anodized Architectural Aluminium details the anodising process.

Surface finishes

The following Standards cover surface coatings to aluminium as per the American Architectural Manufacturers Association (AAMA):

- AAMA 2603-05 – Voluntary Specification, Performance Requirements and Test Procedures for Pigmented Organic Coatings on Aluminium Extrusions and Panels
- AAMA 2604-05 – Voluntary Specification, Performance Requirements and Test Procedures for High Performance Organic Coatings on Aluminium Extrusions and Panels
- AAMA 2605-05 – Voluntary Specification, Performance Requirements and Test Procedures for Superior Performing Organic Coatings on Aluminium Extrusions and Panels



Stove paints or powder coatings can be extremely durable. When these are to be used, specialist advice should be sought from the coating manufacturer regarding specification and suitability (particularly, durability zones) and application of the coatings.

Maintenance

The cleaning of powder coated and anodized material should be performed using hand cleaning and rinsing techniques. The powder coated surface must be regularly maintained in accordance with the powder coating manufacturer's data sheets and in areas where there is a high concentration of salt or atmosphere pollutants, a systematic maintenance program meeting AAMA 610.1 1979 should be implemented. At the very minimum, cleaning should be done at three- to six-month intervals (depending on location, eg seaside or inland, rural or industrial etc.) and is often part of the regular cleaning program associated with items such as the glazing or balustrades of the property.

The following procedure should be adopted:

- remove dust with a wet sponge rather than risk micro-scratching the surface by dry dusting
- most marks or surface contaminants can be removed by the use of a warm, mild detergent or mineral turpentine / white spirit
- always rinse gently afterwards with fresh water so that the contact time of the cleaning solution is kept to a minimum
- high-pressure hosing must be avoided under all circumstances
- dry, preferably with a chamois, or alternatively, a soft cloth
- do not use an abrasive type cleaning agent as this will severely damage the surface of the material
- cleaning of the product should be performed at a time that will allow the aluminium to dry quickly, preferably early in the morning.

***Note:** All coated aluminium surfaces should avoid contact with acids, alkalis, mortar based products and solvents.*

4.3.3 Steel

Steel barriers should be designed in accordance with NZS 3404.1:1997 and related amendments or tested to comply with AS/NZS 1170.0:2002 Appendix B.

4.3.3.1 Mild steel

Corrosion resistance

Bare mild steel has relatively poor corrosion resistance. Use of mild steel without a corrosion-resistant coating is only appropriate in internal non-corrosive environments. Usually it is selected not for its corrosion resistance but for such properties as strength and ease of fabrication. Corrosion protection of steel is covered by Appendix C of NZS 3404:Part 1:1997 which is cited in Verification Method B1/VM1. However, the latest corrosion protection information is contained in section 5 of NZS 3404:Part 1:2009 Steel Structures Standard and should be used in preference.



Galvanising

The following Standards deal with galvanising of steel elements:

- AS/NZS 4680: 2006: Hot-dip galvanised (zinc) coating details the requirements for galvanising
- AS/NZS 4792:2006: Hot-dip galvanised (zinc) coatings on ferrous hollow sections, applied by a continuous or a specialized process.

After fabrication all surface contaminants should be removed. The galvanised coating must be continuous, adherent, smooth and evenly distributed. The element should also be free from any defect that would be detrimental to the use of the element in a barrier. This is particularly relevant to handrails.

4.3.3.2 Stainless steel

Corrosion resistance

Stainless steel does not corrode as easily as mild steel but, unlike its name suggests, it can stain and become dull relatively quickly. Stainless steel is used where the properties of mild steel are required and resistance to corrosion is important. Grade 304 stainless steel should be used only in non-corrosive environments. In corrosive environments such as coastal, swimming pools and geothermal areas, grades 316, 2205 or 445M2 stainless steel should be used.

Surface finishes

The most suitable and common surface finishes used for stainless steel in New Zealand are based on ASTM standard A480/A480M-11a:

- Mill Finish (2B) – Satin
- Brushed (no.4) – Directional Grain
- Bright (BA) – Mirror Finish (polished)

Maintenance

The use of a stainless steel cleaner is recommended to protect the stainless steel. The cleaner should be used once every three months. Stainless steel balustrades exposed to the external environment may require more frequent cleaning if any deterioration of the balustrade is detected.

At a minimum, all exposed stainless steel surfaces should be wiped over with a clean cloth and warm water with a mild detergent on a frequent and routine basis.

For more stubborn dirt or stains use mild, non-scratching abrasion powders such as typical household cleaners. These can be used with warm water, bristle brushes, sponges or clean cloths. For more aggressive cleaning a small amount of vinegar can be added to the powder.

Carbon steel brushes and steel wool must be avoided as they may leave particles embedded in the surface, which can lead to rusting.

The maximum recommended frequency for routine cleaning is once a month, but more often in areas subject to heavy soiling or frequent use.

DOs

- Routine simple and gentle cleaning
- Use cleaners showing “Suitable for stainless steel”
- Employ repeated, routine cleaning rather than an aggressive single cleaning

DON'Ts

- Use coarse abrasive powders
- Use metallic scourers
- Use “Silver cleaners”
- Use in an “abnormal” way

4.3.4 Fabrication

Aluminium is an easy product to fabricate and can be readily manipulated in a cold state. Most aluminium extrusions can be curved, provided the design, alloy and temper are appropriate.

Aluminium extrusions can be mechanically fixed or welded. The most common practice with aluminium is to fix mechanically using stainless steel fixings.

4.3.5 Fixings and connections

Proprietary fixings should be used in accordance with the manufacturer’s instructions. Particular attention needs to be given to minimum edge distances and fixing centres when fixing to substrates, especially timber and concrete.

All fixings and connections including assembly, infill and substrate connections which make up the barrier system must meet the durability requirements of NZBC Clause B2. For guidance on durability in relation to barriers, refer to section 3.8 of this guidance document.

4.3.6 Installation

Installations must be in accordance with the manufacturer’s and engineer’s specifications. Consideration needs to be given to the durability and compatibility of materials in contact (barrier material, fixings and fixing substrate) prior to installation.

4.4 Wire infills

4.4.1 General

Wire infill systems are a popular means of providing a barrier. These have the advantage that the view through the barrier is relatively unimpeded because the wires take up little space. This section provides advice on the design, construction and maintenance of wire barrier systems.

4.4.2. Application of legislation

The current Acceptable Solution F4/AS1 requirements for barriers have been written for systems constructed with stiff elements such as structural sections. Theoretically, the tension in the wire barrier could be quite low so that the wires remained straight in normal service and the dimensional criteria of F4/AS1 were maintained. However, this would not satisfy the intent of the Building Code that children in particular be prevented from climbing through the barrier.

Vertical or near-vertical wires must be spaced and tensioned such that a 100mm diameter steel tube with a conical end cannot pass through any part of the barrier when pulled from the point of the conical section with a force of 150N. This does not mean that the wires may be spaced at 100mm.

4.4.3 Materials

Wire

Generally, the wires must be durable and have sufficient flexibility to allow them to pass around tight corners. The only wires that satisfy this requirement are multi-strand stainless steel wires. Wires that have a 7 x 7 or 7 x 19 lay should be used for all except straight runs with no bends. A 1 x 19 lay has insufficient flexibility and must be used only for straight runs. A diameter not exceeding 2.5mm is best for runs with tight bends included. Larger diameters may be used for straight runs.

The typical stainless steel grades for the wires are grade 304 and grade 316 to ensure satisfactory performance without corrosion over a 15-year minimum life.

Fittings

The fittings to be used with the stainless steel wire should also be stainless steel of either grade 304 or grade 316. The grade is selected to provide the required durability in the particular environment.

Swaged fittings provide for a tidy installation with no possibility of sprags. Alternatively, wire rope grips or copper ferrules may be used with thimbles to create a loop at the end of the wire.

Tensioning of the wire is generally carried out using turnbuckles. The preference is to have lock nuts on the ends of the turnbuckles to ensure the buckle does not unwind over time.



Installation

If the barrier is protecting a difference in level of more than one metre then the system is required to be designed to ensure a child cannot get sufficient purchase on the system to be able to climb over the barrier. This restricts the orientation of the wires to either a vertical or near-vertical orientation spanning between the bottom and upper rail (Figure 4.9).

Figure 4.9 Wire balustrade setup

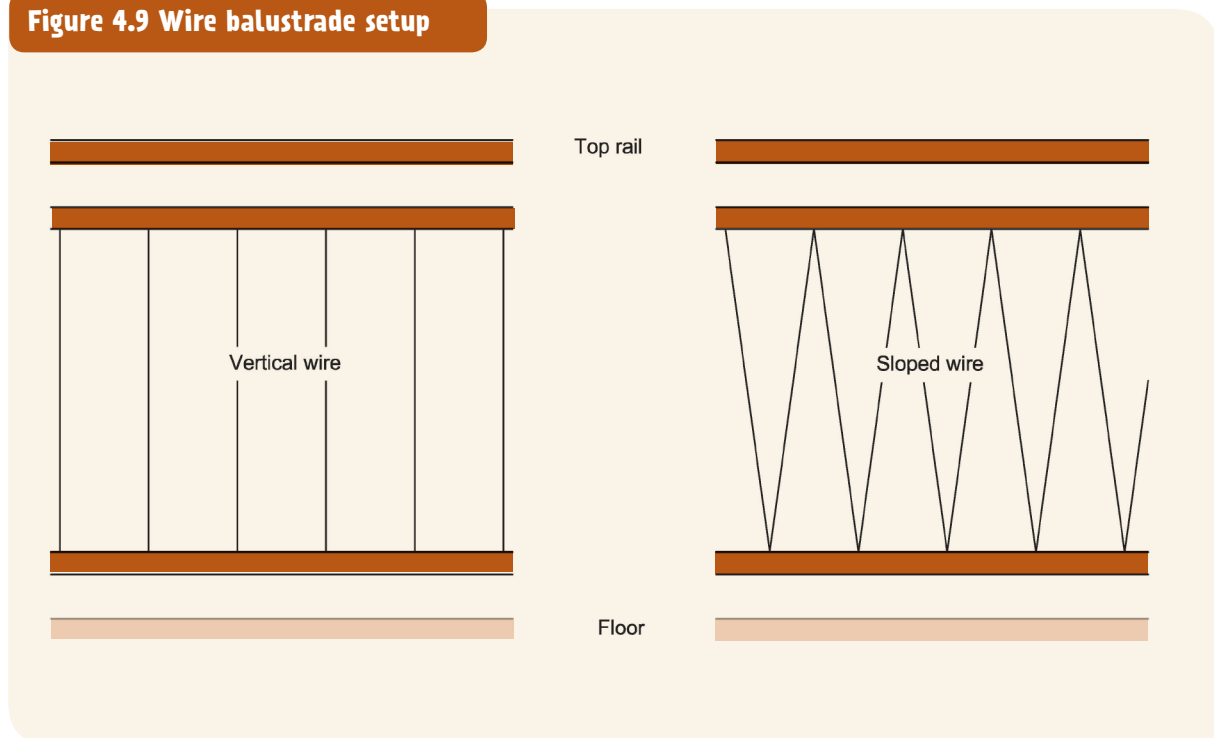

In the case of the vertical wires, the wire may be continuous between the vertical legs (turning through a right angle at each end of the leg as in Figure 4.10). Tension losses are very high at such direction change points, which makes it difficult to achieve an even tension in the wire. It will be necessary to manipulate the wire around the bends in order to maintain an even tension. Even so, it is recommended that tensioners be provided at regular intervals, such as on every sixth leg.

Alternatively, the legs may be individual sections of wire, anchored off at the top and bottom rail. Such an installation presents another problem which must be overcome: as one wire is tensioned, the rails pull together because of their flexibility and this causes adjacent wires to lose tension. A careful balancing of the individual wire tensions is required to achieve a satisfactory installation.

In the case of the sloping wires, invariably the wire is continuous over several legs, often over a complete barrier length between posts. This has the advantage that a more constant tension can be maintained in the wire. While the maximum spacing of the wires still must be 100mm, sufficient tension must be maintained to ensure the wires cannot be forced apart beyond 100mm when the cone is offered up to them and pulled with a 150N force.

Several methods have been used to accommodate the change in direction of the wire. Some examples are shown in Figures 4.11, 4.12 & 4.13.

The individual strands in the wire need to bed down when the wire is tensioned for the first time. This results in permanent stretch of the wire. It is critical to take up the permanent stretch in the wire. It is strongly recommended that the wires are pre-stressed during the swaging and cable manufacturing before they are installed.

Wire supporting structure

Stainless steel sections are usually used as the main rails and posts of a wire barrier system, but aluminium may also be used. Care is required to ensure the stiffness of the rails is sufficient for them to retain straight lines between posts under the tension of the wires.

The use of timber rails is not recommended with vertical and sloping wire barriers because the timber is liable to creep over time and result in an unsightly sagging or hogging rail as well as loose wires.

Figure 4.10 Continuous vertical barrier wires passing round tight 90-degree bends



Figure 4.11 Sloping wires passing through pulley blocks at the direction change



Figure 4.12 Sloping wires passing through saddles at the direction change

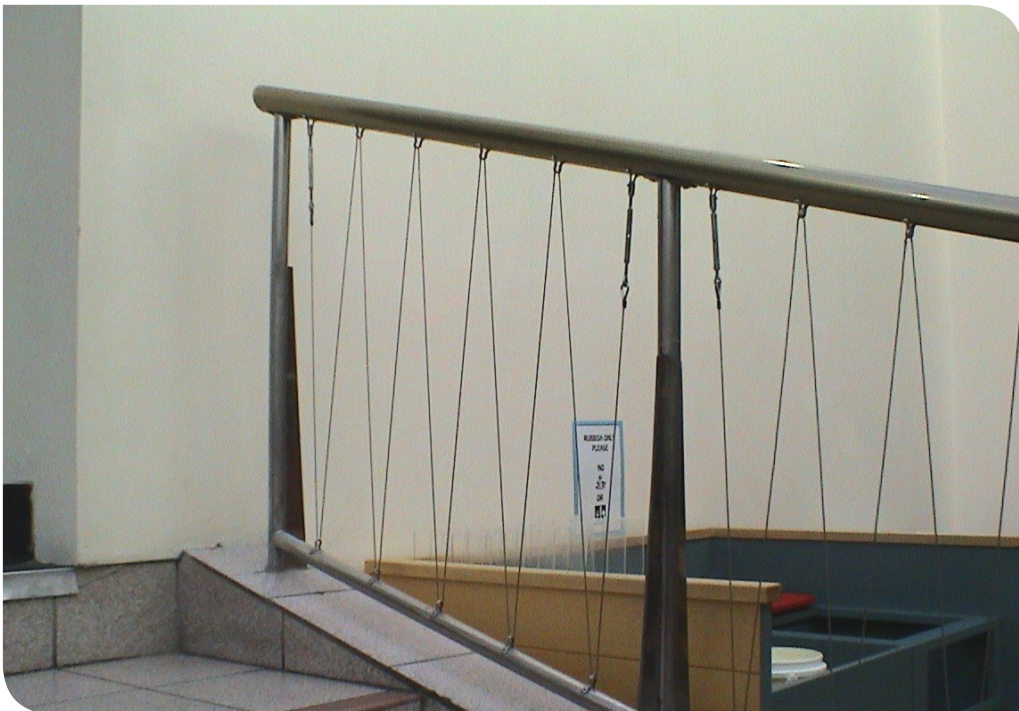

Figure 4.13 Sloping wires changing direction within the rails



Maintenance

As with the solid stainless steel and aluminium sections, routine cleaning is necessary to preserve the appearance of the wire (see section 4.3.3.2, Maintenance). Aluminium is more reactive than stainless steel, but a barrier with aluminium posts and rails and stainless steel wires is not likely to have galvanic corrosion issues because the area of aluminium is significantly greater than the stainless steel with which it will be in contact. Alternatively, the wire could be coated with a non-metallic sheath that would prevent the two metals from coming into contact with each other.

Good practice for a satisfactory performance of the wire barrier

1. The wires require sufficient bending flexibility to ensure they can change direction sharply but still transfer the tension load around the bend. It is desirable that this is assisted by passing the wires around a pulley block at each direction change.
2. The tensioning devices should not be spaced so far apart that they cannot take up the “stretch” in the wire before reaching the end of their travel.
3. During the process of tensioning a continuous wire the wire should be manipulated around the direction change points to ensure the tension is transferred to the spans most remote from the tensioning device.

4.5 Concrete

4.5.1 General

Concrete is the material most commonly used in the supporting structure rather than for the barrier itself. However, concrete is a good material to use for a barrier when high strength is required such as barriers in areas susceptible to over-crowding, e.g. sports stadiums. Furthermore, in locations where access for maintenance and inspection may be difficult, concrete can be a good choice of material for the barrier because of its ability with suitable specification, detailing and workmanship to deliver a product requiring relatively little maintenance to achieve an intended 50-year life.

4.5.2 Materials

All concrete should be in accordance with the requirements of NZS 3104: 2003 Specification for Concrete Production. All reinforcement should comply with the requirements of AS/NZS 4671:2001: Steel reinforcing materials.

4.5.3 Design

All design should be in accordance with the requirements of NZS 3101:Part1: 2006: Concrete Structures Standard.

4.5.4 Durability

The durability requirements of the NZBC can be met by using Section 3 of NZS 3101:Part 1:2006 as modified by B2/AS1.

4.5.5 Construction and installation

All concrete construction should be in accordance with NZS 3109:1997: Concrete Construction.

Where barrier assemblies are fixed to a concrete supporting structure, it is important to ensure post-drilled proprietary fixings do not clash with the reinforcement in the concrete substrate. Furthermore, due to the relatively high load demands on the post-drilled proprietary fixings, it is important to ensure a proper fixing design is carried out in accordance with the manufacturer's instructions and technical guidance taking into account such things as concrete strength, fixing embedment, fixing centres and edge distances.

The surface finish to concrete barriers should be smooth and clear of any projections that could cause injury. Edges should be chamfered. Due to the difficulties achieving a suitably smooth handrail in concrete, it is usual to have handrails made from metal or timber fixed to the top or sides of the barrier.

4.5.6 Maintenance

Concrete supporting structures and barriers designed and constructed in accordance with the Standards listed in this section of the document should require only normal maintenance in order to achieve durability requirements set out in B2 of the NZBC. Periodic inspections are advisable to ensure the concrete has not become damaged by abrasion or impact reducing cover to the reinforcement.





5.0 Checklist

The following checklist is intended to assist the designer, installer and BCA to determine that the design and documentation is sufficiently adequate and complete.

Things to consider	✓
Initial considerations?	
Is the proposal a barrier?	
Is the proposal a Specific Engineered Design?	
Is an engineer required?	
Is the deck designed to NZS 3604:2011 - 7.4?	
What type of barrier is proposed: glass, timber, metal, wire infill, concrete or a combination?	
Is a handrail required?	
Design of barriers	
B1	
Has the appropriate occupancy type (Table 3.3 of AS/NZS 1170.1) been used?	
Has the barrier been designed in accordance with the loads specified in AS/NZS 1170?	
Does the design take account of barrier top edge line loads, infill loads and concentrated loads?	
Have wind loads been considered, i.e. is the barrier outside, in a high-wind zone or on a high-rise building?	
Has consideration been given to barrier deflections, and is rotation of the supporting structure likely?	
Are the fixings to the supporting structure sufficiently designed and detailed?	
If the barrier design is based on testing, was the testing sufficiently robust and thorough (see Appendix B of AS/NZS 1170.0)?	
B2	
Is the durability of the barrier appropriate for its purpose, location and accessibility (see Acceptable Solution B2/AS1)?	
F4	
Does the barrier geometry and height conform to NZBC Clause F4 Acceptable Solution 1, e.g. toeholds?	



Things to consider (cont.)



Materials

Glass

Have the design criteria in this design guide been used?

If not, has compliance been established?

Timber

Have the members and joints been designed in accordance with NZS 3603 Timber Structures Standard?

Have green timber stresses been used in the design where the barrier is external and exposed to the weather ?

Is the timber treatment appropriate for the durability requirements of the barrier?

Metal

Have the design criteria in this design guide been used?

Has compliance been established by other means?

Concrete

Has the barrier been designed in accordance with NZS 3101 Concrete Structures Standard?

Are the materials and construction in accordance with NZS 3104 and NZS 3109?

If proprietary drilled-in fixings are proposed, have they been sufficiently designed and detailed for the application?

Maintenance

What are the manufacturer's requirements for maintenance?

Have the property owners been notified of the maintenance requirements?

Producer statements

Is the producer statement (PS1) site and job specific?

Is the PS3 for the same system as approved on the Building Consent?

Has other evidence has been provided to show compliance?





6.0 References

Building Act 2004	1.1, 2.0
Fencing of Swimming Pools Act 1987	Figure 3.1
New Zealand Building Code	1.1, 2.0
New Zealand Building Code	
Clause B1 Structure	2.0, Table 2.1, 3.4, Table 4.1, Table 4.2, Table 4.3, Table 4.4, Table 4.5, Table 4.6, Table 4.7, Table 4.8, Table 4.9, Table 4.10
Clause B2 Durability	2.0, Table 2.1, 3.8, Table 4.1, 4.2.4
Clause D1 Access routes	2.0, Table 2.1
Clause E2 External moisture	2.0, Table 2.1, 3.8
Clause F2 Hazardous building materials	2.0, Table 2.1
Clause F4 Safety from falling	1.1, 2.0, Table 2.1, 3.4, 4.2.7.1
Compliance Document	
B1/VM1	3.4, 3.5, Table 4.1, Table 4.2, Table 4.3, Table 4.4, Table 4.5, Table 4.6, Table 4.7, Table 4.8, Table 4.9, Table 4.10, 4.3.3.1
B1/AS1	4.1.3
B2/AS1	3.8, Figure 3.22, 4.2.4, 4.2.7, 5.0
D1/AS1	1.2, Figure 1.2, 4.1.5
E2/AS1	3.8
F2/AS1	4.1.2
F4/AS1	3.3, 5.0
Standards New Zealand	
AS/NZS 1170 Structural design actions	3.2, Table 4.1, Table 4.2, Table 4.3, Table 4.4, Table 4.5, Table 4.6, Table 4.7, Table 4.8, Table 4.9, Table 4.10
Part 0:2002 General principles	3.4, 3.10, 4.3.2, 4.3.3, 5.0
Part 1:2002 Permanent, imposed and other actions	3.4, Table 3.3, 3.5, 3.10, 5.0
Part 2:2002 Wind actions	3.4
AS/NZS 1664: Aluminium structures	4.3.2
Part 1:1997 Limit state design	



AS/NZS 4671:2001 Steel reinforcing materials	4.5.2
AS/NZS 4680:2006 Hot-dip galvanised (zinc) coating	4.3.3.1
AS/NZS 4792:2006 -dip galvanised (zinc) coatings on ferrous hollow sections	4.3.3.1
NZS 3101 Concrete structures standard Part 1:2006 The design of concrete structures	4.5.3, 4.5.4, 5.0
NZS 3104:2003 Specification for concrete production	4.5.2, 5.0
NZS 3109:1997 Concrete construction	4.5.5, 5.0
NZS 3404:Part 1:1997 Steel structures standard	4.3.3, 4.3.3.1
NZS 3404:Part 1:2009 Steel structures standard	4.3.3.1
NZS 3602:Part 1:2003 Timber and wood based products for use in building	4.2.7.1
NZS 3603:1993 Timber structure standard	4.2.1, 4.2.2, 4.2.3, 4.2.4
NZS 3604:2011 Timber-framed buildings	4.2.7.2, Figure 4.8
NZS 4203:1992 Loadings standard	4.1.3
NZS 4223: Glazing in buildings Part 1:2008 Glass selection and glazing	Table 4.2, Table 4.3, Table 4.4, Table 4.5, Table 4.6, Table 4.7, Table 4.8, Table 4.9, Table 4.10, 4.1.7
Part 3:1999 Human impact safety requirements	1.2, 4.1.1, 4.1.3, 4.1.3.1, Figure 4.2
Part 4:2008 Wind, dead, snow and live actions	4.1.3
NZS 8500 Safety barriers and fences around swimming pools, spas and hot tubs	Figure 3.1
American Society of Testing and Materials	
ASTM A480/A480M-11a Standard specification for flat rolled stainless steel and heat-resisting steel plate, sheet and strip	4.3.3.2
ASTM E2353 Standard Test Method for Performance of Glass in Permanent Glass Railing Systems, Guards and Balustrades	4.1.4.3 Note 5
British Standards Institution	
BS EN 13200: 2005 Spectator facilities Part 3: Separating elements – Requirements and guide to safety at sports grounds	3.4



American Architectural Manufacturers Association

AAMA 610.1:1979 Voluntary guide specification for cleaning and maintenance of painted aluminum extrusions and curtain wall panels	4.3.2
AAMA 611-98 Voluntary standard for anodised architectural aluminum	4.3.2
AAMA 2603-05 Voluntary specification, performance requirements and test procedures for pigmented organic coatings on aluminum extrusions and panels	4.3.2
AAMA 2604-05 Voluntary specification, performance requirements and test procedures for high performance organic coatings on aluminum extrusions and panels	4.3.2
AAMA 2605-05 Voluntary guide specification performance requirements and test procedures for superior performing organic coatings on aluminum extrusions and panels	4.3.2





7.0 Index for Diagrams

Figure 1.1 Barrier elements	5
Figure 1.2 Handrail/top rail for timber barriers	5
Figure 3.1 Barrier design procedure	9
Figure 3.2 Stair barriers in areas likely to be frequented by children under six years of age	11
Figure 3.3 Examples of barrier geometries	12
Figure 3.4 Barrier loads for areas susceptible to overcrowding	15
Figure 3.5 Domestic and residential barriers with rails	17
Figure 3.6 Domestic and residential barriers without a rail	18
Figure 3.7 Non-domestic and non-residential barriers	20
Figure 3.8 Infill loads on barriers	21
Figure 3.9 Concentrated loads on barriers	23
Figure 3.10 Horizontal deflection of post and rail balustrade	26
Figure 3.11 Assessment of durability for barriers	29
Figure 3.12 Barrier and supporting structure durability requirements	29
Figure 4.1 Typical stress concentrations around holes in glass barriers	33
Figure 4.2 Fully-framed glazing safeguarding against a fall of one metre or more	34
Figure 4.3 Glass fixed with disc fitting to metal tab	50
Figure 4.4 Glass fixed with spider fitting to post	51
Figure 4.5 Glass cantilever fixed with double disc fitting to concrete	52
Figure 4.6 Glass cantilever fixed with clamp plate to steel beam	53
Figure 4.7 Handrail fittings to glass	54
Figure 4.8 Structural post to joist connection	57
Figure 4.9 Wire balustrade setup	64
Figure 4.10 Continuous vertical barrier wires passing round tight 90-degree bends	65
Figure 4.11 Sloping wires passing through the pulley blocks at the direction change	66
Figure 4.12 Sloping wires passing through saddles at the direction change	66
Figure 4.12 Sloping wires changing direction with the rails	67



8.0 Index for Tables

Table 2.1 Relevant Building Code clauses	6
Table 3.1 Minimum barrier heights	10
Table 3.2 Barrier loadings for areas susceptible to overcrowding	13
Table 3.3 Barrier imposed loads	14
Table 4.1A Full-height, partly-framed glazing safeguarding against a fall of one metre or more – line, concentrated and uniform loads	35
Table 4.1B Full-height, partly-framed glazing safeguarding against a fall of one metre or more – concentrated and uniform loads	36
Table 4.2 Balustrade infill – four-edge support	38
Table 4.3 Balustrade infill – two-edge support	39
Table 4.4 Balustrade infill – two-edge, point fixed, structural handrail in front of glass	40
Table 4.5 Balustrade infill – two-edge, point fixed	41
Table 4.6 Balustrade infill – two-edge, clamped (no holes in glass)	42
Table 4.7 Structural balustrade infill – cantilevered glass	44
Table 4.8 Structural balustrade – two-edge point fixed	45
Table 4.9 Structural balustrade – two-edge support	46
Table 4.10 Structural balustrade – three-edge support	47

